



2025

SPORTS equipment

COURTS | FIELDS | INDOOR



Court Nets and Accessories

CONSISTENT QUALITY:

With Douglas® nets, you get consistent, long-lasting performance. All Douglas® nets meet USTA or USAPA's requirements for official net sizes. In addition, Douglas® nets carry a pro-rated warranty guaranteeing superior durability and longer net life. See for yourself why Douglas® nets are the brand of choice. All nets include lacing cord. Center straps are sold separately.

NETTING:

Netting is 1-3/4" square mesh braided solid core polyethylene unsurpassed for durability and weather resistance. Nets are made from 3.5 mm with 325# break strength or from 3.0 mm with 285# break strength.

HEADBANDS:

Headbands are constructed using heavy-duty vinyl coated polyester or durable polyester webbing material that withstands the elements and won't shrink, rot or mold. Headbands are sewn to the netting with four rows of #32 white polyester thread -the heaviest in the industry.

BOTTOM/SIDE POCKET TAPES:

Bottom and side pocket tapes are made of heavy-duty vinyl coated polyester and won't shrink, mildew or rot when exposed to the elements. The included 1/2" fiberglass dowels in the side pockets keep the net taut for a professional appearance. Heavy duty brass grommets and lacing cord lets you pull the net snugly up to each post.

CABLE:

All Douglas® nets come complete with a vinyl coated, 5/32" galvanized steel cable with break strength of 2300#. Both ends have double-swaged loops.

OPTIONS:

Some tennis nets have double netting on the top six rows. This allows for increased durability of the net since the top rows are the area of the net that tennis balls hit the most leading to net fatigue. Tapered nets are also available, nets are tapered in the middle for a cleaner look and increased durability.

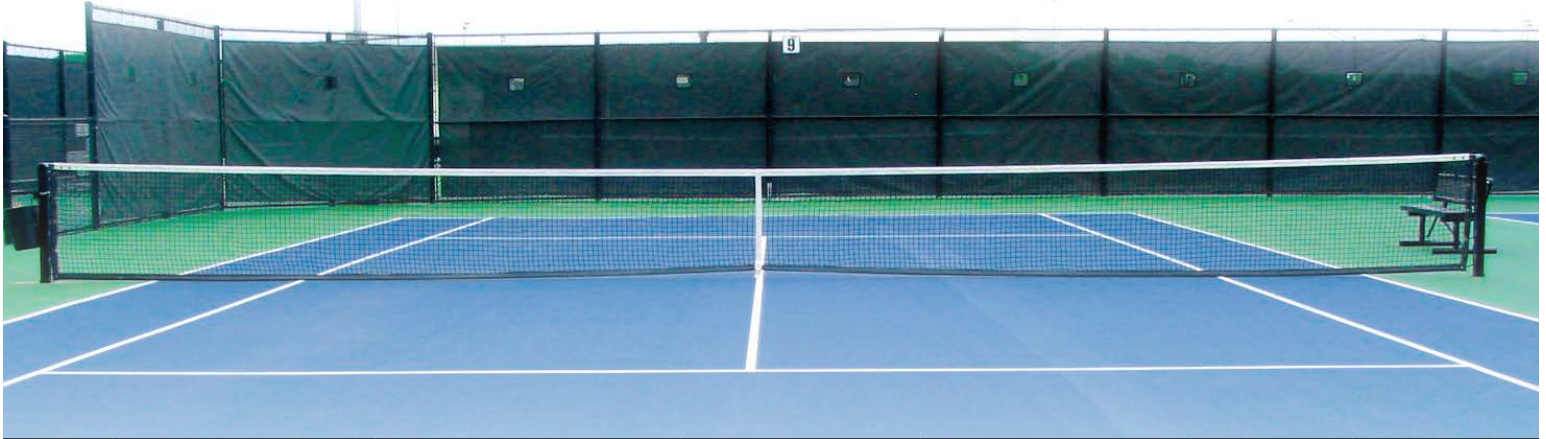

		Headband		Netting			
Item #	Net	Material	Weight	Size	Break Strength	Top 6 Rows Double Mesh	Warranty
PROFESSIONAL TENNIS NETS - - - USA Manufactured by Douglas® - - -							
20045	TN-45	Double thick 100% polyester	48 oz.	3.5 mm	325 lb.	No	5 Year Warranty
CHAMPIONSHIP TENNIS NETS							
30036T	TN-36 -tapered	Vinyl Coated Polyester, 2-ply	65 oz. (20 oz./sq.. yd.)	3.5 mm	325 lb.	No	5 Year Warranty
30038TD	TN-36DMT -tapered	Vinyl Coated Polyester, 2-ply	65 oz. (20 oz./sq.. yd.)	3.5 mm	325 lb.	Yes	5 Year Warranty
30060	TN-28DM	Durable Polyester Web	N/A	3.5 mm	325 lb.	Yes	5 Year Warranty
TOURNAMENT TENNIS NETS							
30029	TN-30	Vinyl Coated Polyester	32 oz./sq.. yd.	3.0 mm	285 lb.	No	4 Year Warranty
30030	TN-30DM -tapered	Vinyl Coated Polyester, 2-ply	65 oz. (20 oz./sq.. yd.)	3.0 mm	285 lb.	Yes	4 Year Warranty
SPECIALTY TENNIS NETS							
20305	STN-36, 42" x 32'9"L Singles Tennis Net	Vinyl Coated Polyester, 2-ply	65 oz. (20 oz./sq.. yd.)	3.5 mm	325 lb.	No	4 Year Warranty
20008	PTN-28, 32" x 21'10" Paddle Tennis Net	Vinyl Coated Polyester, 2-ply	65 oz. (20 oz./sq.. yd.)	3.0 mm	285 lb.	No	4 Year Warranty
20009	PLTN-28, 36" x 23' Platform Tennis Net	Vinyl Coated Polyester, 2-ply	65 oz. (20 oz./sq.. yd.)	3.0 mm	285 lb.	No	4 Year Warranty
PICKLEBALL NETS							
20105	JTN-30, 36" x 21'9"L Standard Pickleball	Vinyl Coated Polyester, 2-ply	65 oz. (20 oz./sq.. yd.)	3.0 mm	285 lb.	No	4 Year Warranty
20103	PN-30, 31" x 21'9"L Shorter Pickleball Height	Vinyl Coated Polyester, 2-ply	65 oz. (20 oz./sq.. yd.)	3.0 mm	285 lb.	No	4 Year Warranty

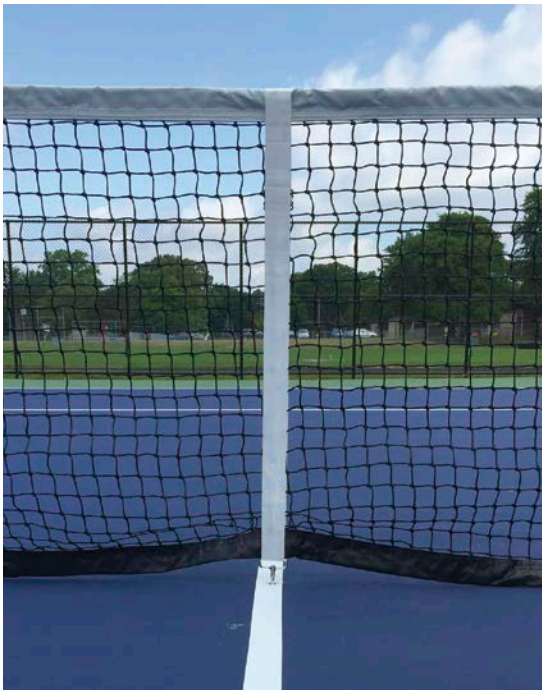

TN-30 | Deluxe Center Strap



TN-45



TN-36



TN-28DM

Adjustable Center Straps

All straps are made from heavy-duty 2" polyester white webbing, nickel plated web slides and snaps.

Velcro (Item # 20601)

Velcro adjustment, with swivel loop bolt snap

Classic (Item # 20603)

Non-slip reverse web slide with double ended snap

Deluxe (Item # 20600)

Two non-slip reverse web slides with swivel loop bolt snap

Center Pipe Anchor (Item # 63428)

1.9" OD Galvanized Steel



Replacement Cables

47' Tennis Cable (RVC-47) (Item # 20647)

27' Pickleball Cable (RVC-27) (Item # 20627)

1/4" Galvanized steel cable is vinyl coated and looped each end.



Lacing Cord

(TNLC) (Item # 10338)

Tennis net lacing cord includes (2) pieces of 4 mm white polyester braided cord 4' long and (2) pieces 3 mm braided polyethylene 15' long.

Cord 3 mm (Item # 10337)

500' spool of 3 mm braided polyethylene



Singles Sticks

(Item # 34753)

Single sticks provide proper 42" net height for singles play. These silver singles sticks are made from 3/4" aluminum with protective end caps and injection-molded "V" groove for the net headband. Sold per pair.



Douglas® Tennis Posts



○ Premier™ XS Posts

- Plated Gears Green (Item # 63032)
Black (Item # 63034)
- Stainless Steel Gears Green (Item # 63032SS)
Black (Item # 63034SS)
- Brass Gears Green (Item # 63032BR)
Black (Item # 63034BR)

2 7/8"

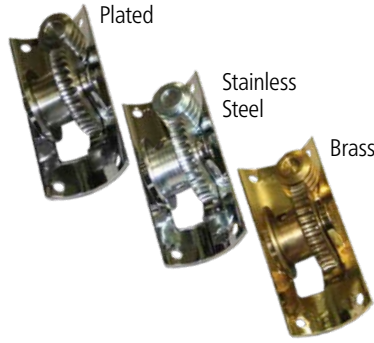

The Premier™ XS Series is the Cadillac of tennis posts; providing first-class looks and durability for both indoor and outdoor court applications.

These 2-7/8" OD round posts are constructed of 8-gauge steel. Posts feature Allied's® superior Flo-coat® galvanization process and are then finished in forest green or black baked-on polyester powder coat to resist rust and increase durability. Integrated welded steel lacing rods are included for a professional net installation.

Posts are internally wound and feature a jam-free cable tensioning hardware system. Choose from plated steel, stainless steel or brass gears. Gear housings and caps are made of die-cast zinc. Gear function is 30:1 to ensure a smooth, easy operation. Flush mounted gear plate cover and removable handle are offered in chrome or brass finish.

Corresponding Ground Sleeves:
24" PVC Ground Sleeve (GS-24PVC) (Item # 63164)
24" Aluminum Ground Sleeve (GS-24RD) (Item # 63171)



○ DTP-37

- Green (item # 63007)
- Black (item # 63008)

3"

The dependable DTP-37 post is a sturdy design that has been a tennis court staple for decades.

These 3" OD posts are comprised of extra-heavy 7-gauge steel. Posts are internally wound and feature a self-locking gear mechanism. Gears are constructed of plated steel and the small gear is case hardened. Gear function is 30:1 to ensure a smooth, easy operation. The sleek gear housing and caps are made of cast aluminum alloy. Posts are finished in forest green or black baked-on polyester powder coat finish to resist rust and increase durability. Integrated welded steel lacing rods are included for a professional net installation. The side mounted removable handle is chrome plated.



Corresponding Ground Sleeves:
24" Steel (GS-24) (Item # 63424)

○ Sidewinder

- Green (Item # 63001)
- Black (Item # 63003)

2 7/8"

These recreational workhorse posts are designed for tough wear making them ideal for parks or school tennis courts.

These 2-7/8" classic external wind posts are constructed of 8 gauge steel. The posts, external gears and handle are finished in forest green or black baked-on polyester powder coat finish to resist rust and increase durability. Integrated welded steel lacing rods are included for a professional net installation. The aluminum deluxe reel offers a smooth adjusting operation with a side mounted removable handle.



Corresponding Ground Sleeves:
24" PVC (GS-24PVC) (Item # 63164)
24" Aluminum (GS-24RD) (Item # 63171)



○ Premier™ RD
Green (Item # 63050)
Black (Item # 63051)



Premier™ SQ
Green (item # 63053)
Black (item # 63054)



These popular posts provide classic good looks and durability for either indoor or outdoor court applications.

The Premier™ 3" OD round (RD) and 3" square (SQ) posts are constructed of heavy-duty 11-gauge steel. Posts are internally wound and feature a self-locking gear mechanism. Gears are constructed of plated steel and the small gear is case hardened. Gear housings and caps are made of cast aluminum alloy. Gear function is 30:1 to ensure a smooth, easy operation. Posts are finished in forest green or black baked-on polyester powder coat finish to resist rust and increase durability. Integrated welded steel lacing rods are included for a professional net installation. Flush mounted gear plate cover and removable handle are chrome plated.



Corresponding Ground Sleeves:

24" Steel Ground Sleeve (GS-24) (Item # 63424)

24" Square Aluminum Ground Sleeve (GS-24SQ/AL) (Item # 63172)



○ Premier™ SQ Surface Mount Black (Item # 63060)
Eliminate ground sleeves and easily install these surface mount tennis posts indoor or outdoor. These surface mount posts boast all the features of the standard Premier™ SQ posts except they offer a heavy-duty bottom welded base plate to secure posts to concrete court surface.

○ Douglas® PPS-SQ Heavy-Duty Portable Tennis Systems

42' Standard Tennis Court 42"h x 42'l PPS-42SQ (Item # 63100)
33' Singles Tennis Courts: 42"h x 33'l, PPS-33SQ (Item # 63133)

These portable systems raise the bar and are the gold standard when permanent installation is not desired for either indoor or outdoor court applications.

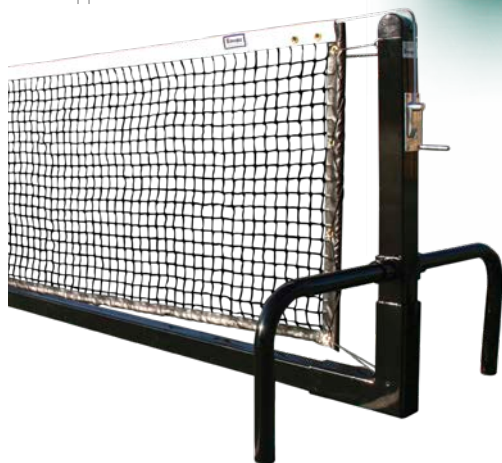

Portable PPS-SQ systems are easy-to-assemble and offer the same long-lasting features as the classic Premier™ SQ tennis post. The 3" square tennis post is constructed from heavy-duty 11-gauge steel and are internally wound featuring a self-locking gear mechanism. Gears are constructed of plated steel and the small gear is case hardened. Gear housings and caps are made of cast aluminum alloy. Gear function is 30:1 to ensure a smooth, easy operation. Systems are finished with black baked-on polyester powder coat to resist rust and increase durability. Heavy-duty base frame is also constructed of 11-gauge 3" square steel and 3-1/2" square 3/16" heavy-wall steel. Net easily attaches with the top cable and to an eye-bolt on the base frame; no lacing rods are needed. Systems are complete with the 3.5 mm TN-28 tennis net and a Velcro center strap. Flush mounted gear plate cover and removable handle are chrome plated. System is available in (2) sizes, 42' x 42"h Standard Tennis and 33' x 42"h Singles Tennis. Custom sizes are available up to 42' long and 42" high. The transporter features heavy-duty non-scurr swivel casters; (2) End and (1) Center caster assembly. Casters allow unit to pivot one end at a time for smoother transportability.

○ Replacement Reels

Replacement reels for external wind tennis posts. All hardware is included and handles are removable. Finished with black or green powder coat finish.



Deluxe Reel
Green (Item # 53433)
Black (Item # 53433B)
Aluminum construction with a smooth operation. Slotted to fit most posts.

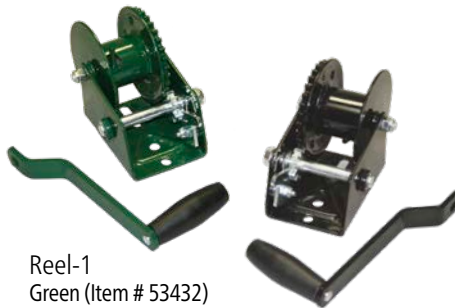

Reel-1
Green (Item # 53432)
Black (Item # 53432B)
Heavy-duty steel construction with a smooth operation. Slotted to fit most posts.

○ Ground Sleeve T-Plugs

2-7/8" & 3" OD (Item # 63418)
3.5" OD (Item # 63419)
3" SQ (Item # 63420)
3.5" SQ (Item # 68155)

Steel t-plugs to cover and fit into Douglas® ground sleeves. Finished with a black baked on polyester powder coat finish.



Douglas® Pickleball



○ Pickleball Premier™ XS Posts

- Plated Gears Green (Item # 63074)
 Black (Item # 63075)
- Stainless Steel Gears Green (Item # 63074SS)
 Black (Item # 63075SS)
- Brass Gears Green (Item # 63074BR)
 Black (Item # 63075BR)

2 7/8"

The Cadillac of posts is also available for pickleball court construction measuring 54" in length to sit 36" above ground. These 2-7/8" OD round posts are constructed of 8-gauge steel. Posts are internally wound and feature a jam-free cable tensing hardware system. Choose from plated steel, stainless steel or brass gears. Plated steel gear housings and caps are made of die-cast zinc. Gear function is 30:1 to ensure a smooth, easy operation. Posts feature Allied's® superior Flo-coat® galvanization process and are then finished in forest green or black baked-on polyester powder coat to resist rust and increase durability. Integrated welded steel lacing rods are included for a professional net installation. Flush mounted gear plate cover and removable handle are chrome plated.

Corresponding Ground Sleeves:

- 24" PVC
(GS-24PVC) (Item # 63164)
- 24" Aluminum
(GS-24RD) (Item # 63171)



○ Pickleball Premier™ RD Posts

- Green (Item # 63070)
- Black (Item # 63071)

3"

These popular posts are designed for pickleball court construction measuring 54" in length to sit 36" above ground. The Premier™ 3" OD round (RD) posts are constructed of heavy-duty 11-gauge steel. Posts are internally wound and feature a self-locking gear mechanism. Gears are constructed of plated steel and the small gear is case hardened. Gear housings and caps are made of cast aluminum alloy. Gear function is 30:1 to ensure a smooth, easy operation. Posts are finished in forest green or black baked-on polyester powder coat finish to resist rust and increase durability. Integrated welded steel lacing rods are included for a professional net installation. Gear plate cover and removable handle are chrome plated.

Corresponding Ground Sleeves:

- 24" Steel
(GS-24) (Item # 63424)



○ SW-36 Deluxe Pickleball Posts

- Green (Item # 63078)
- Black (Item # 63079)

2 1/8"

These recreational workhorse posts are designed for pickleball court construction measuring 54" in length to sit 36" above ground. These classic external wind posts are constructed of 8 gauge steel in 2-7/8" OD. The posts, external gears and handle are finished in forest green or black baked-on polyester powder coat finish to resist rust and increase durability. The aluminum deluxe reel offers a smooth adjusting operation with a side mounted removable handle.

Corresponding Ground Sleeves:

- 24" PVC
(GS-24PVC) (Item # 63164)
- 24" Aluminum
(GS-24RD) (Item # 63171)

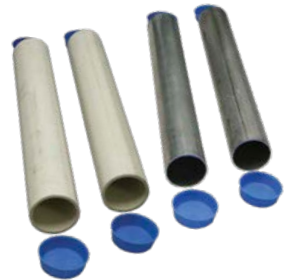

○ Pickleball Nets

These Douglas® nets meet the USAPA's requirements for official Pickleball net sizes. Nets boast the same features as our Douglas® tennis nets and carry a 4 year warranty. Custom sizes are available.

- JTN-30
36"h x 21'9"l (Item # 20105)

- PN-30 -Optional shorter height
31"h x 21'9"l (Item # 20103)



○ Pickleball Premier™ SQ Surface Mount Black (Item # 63080)

Easily convert existing tennis courts to pickleball courts with these easy-to-install surface mount posts. These 36" high posts boast all the features of the standard Premier™ SQ posts except they offer a heavy-duty bottom welded base plate to secure posts to the playing surface. The Premier™ SQ posts are constructed of heavy-duty 11-gauge steel. Posts are internally wound and feature a self-locking gear mechanism. Gears are constructed of plated steel and the small gear is case hardened. Gear housings and caps are made of cast aluminum alloy. Gear function is 30:1 to ensure a smooth, easy operation. Posts are finished in black baked-on polyester powder coat finish to resist rust and increase durability. Integrated welded steel lacing rods are included for a professional net installation. Gear plate cover and removable handle are chrome plated.



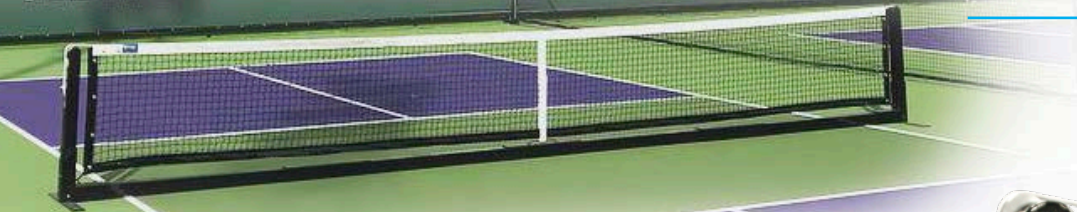

Lift assist handles are included for each end



○ Douglas® PPS22-SQ Portable Pickleball 36"H x 22'L (Item # 63122)
 Portable PPS-SQ systems are easy-to-assemble and offer the same long-lasting features as the classic Premier™ SQ tennis post. The 3" square post is constructed from heavy-duty 11-gauge steel. This portable system is supported by unique flat stabilizer legs that offer a greater range of play and increases player safety. Post is internally wound and features a self-locking gear mechanism. Gears are constructed of plated steel and the small gear is case hardened. Gear housings and caps are made of cast aluminum alloy. Gear function is 30:1 to ensure a smooth, easy operation. Systems are finished with black baked-on polyester powder coat to resist rust and increase durability. Heavy-duty base frame is also constructed of 11-gauge 3" square steel and 3-1/2" square 3/16" heavy-wall steel. Net easily attaches with the top cable and to an eye-bolt on the base frame; no lacing rods are needed. Systems are complete with the PN-30 Pickleball net and a Velcro center strap. Flush mounted gear plate cover and removable handle are chrome plated. The end wheel assembly features heavy-duty non-scurf swivel casters that allow for smooth and easy mobility. The wheel assembly bracket simply flips up and out of the way while unit is in play.

Best application is for dedicated pickleball courts.

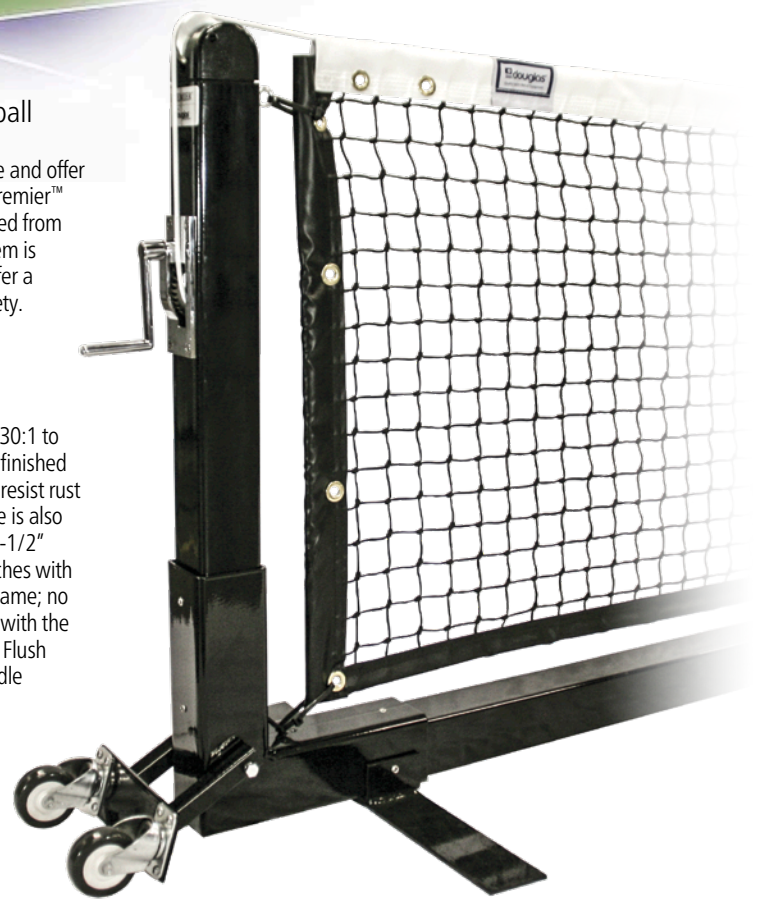

○ Douglas® Pickle-MAX Portable Pickleball System 36"H x 22'L (Item # 33150)
 The Pickle-MAX by Douglas® Portable Pickleball Set is a great solution to play Pickleball anywhere and it's the most robust unit in its class. At nearly 60 lbs., this system is heavy-duty enough not to be blown over by moderate wind, but also easy to move with the 4" wheels that can lock the system in place. The 4" wheels allow pickleballs to roll underneath, which is desired by many avid players. The framework is made from structural rectangular steel, the ends are 1-1/2" X 2-3/8" with 1-1/2" round upright poles, and 1-1/2" square pieces interconnect to form the base frame. All steel parts are finished with a black baked-on polyester powder coat to resist rust and increase durability. The net is made with durable high-density polyethylene netting with black vinyl side pockets and a white vinyl headband and center support strap. The net maintains proper net tension and with the center support strap, there's no sagging. The system can be used indoors or outdoors and is completely weather-treated for year-round use. The rolling carrying bag makes transporting easy, and assembly takes about 5 minutes. This portable system meets all USA pickleball specifications; 22' wide, 36" high at the ends, and 34" high at the center.



Douglas® Pickleball Court Dividers

Permanent Court Dividers

- Divider Post Set 2-7/8" OD (Item # 63200)
- Pole Pad with Adjustable Straps (Item # 29225)
- GS-24 RD/Alum Ground Sleeve (Item #63171)
- GS-24RD/PVC Ground Sleeve (Item #63164)

With Douglas® Pickleball court divider systems there's no more retrieving errant balls or getting interrupted by pickleballs from opposing courts. These Pickleball court dividers are manufactured to your own custom court dimensions. Court dividers are supported by standard height 4' high steel poles with your choice of mesh windscreen or divider netting. Maximum recommended width is up to 40' however, custom widths longer than 40' are available upon special request. The standard in-ground support poles are 8-gauge steel in 2-7/8" OD. Poles and hardware collars are finished with a black baked-on polyester powder coat to resist rust and increase durability. All hardware components for the tension cable system are comprised of galvanized steel for maximum strength and longevity.

Divider panels are custom fabricated from either VCP or VCP MAX windscreen mesh or from #420 Knotless Pylon netting. Both divider panel options are sewn with a top headband pocket that conceals all the tension hardware for an attractive finish with no exposed components. The sides and bottoms of the divider panels have reinforced tape borders that are double sewn with 1-1/2" solid vinyl and complete with #2 brass grommets spaced evenly for easy installation.

The optional wraparound pole pad is 4' high and is 17" wide to completely wrap around the pole. The pad is secured around the pole with double stitched Velcro straps. Padding is comprised of two-inch-thick high impact foam that is wrapped in all-weather vinyl that is mildew and UV resistant.

Complete system includes poles, divider panel, tension hardware. Ground sleeves and protective pole padding are optional. Additional court configuration options such as add-on corner and center poles can be added to your court divider layout.



Movable Court Dividers

- 4'H x 42'L (Item # 63242)
- 4'H x 31'6"L (Item # 63232)
- 4'H x 21'L (Item # 63221)

With the Movable Douglas® Pickleball Court Divider Systems, there's no need to drill into your indoor court or install ground sleeves. Pickleball court separation is essential, so there's no more retrieving errant balls or getting interrupted by pickleballs from opposing courts.

The mesh divider panel is supported by a movable 4' high steel base frame in three lengths. The divider panel is hung on a tensioned cable between the upright posts and secured along the bottom at each frame connection.

The 3" square vertical posts are constructed from heavy-duty 11-gauge steel. Heavy-duty base frame is also constructed of 3/16" wall 11-gauge 3" square steel. The divider system is finished with a black baked-on polyester powder coat to resist rust and increase durability.

All hardware components for the tension cable system are comprised of galvanized steel for maximum strength and longevity. Hardware includes 1/4" cable clamps, turnbuckles, and attachment components.

Divider panels are fabricated from VCP or VCP MAX windscreen at 3'6"H to fit inside the framework. Windscreen length is 4" less than the frame size. The mesh divider panel is sewn with a top headband pocket that conceals all the tension hardware for an attractive finish with no exposed components. The sides and bottoms of the divider panel have reinforced tape borders that are double-sewn with 1-1/2" solid vinyl and complete with #2 brass grommets spaced evenly for easy installation.

The mesh VCP windscreen material offers an excellent visual blockage, and custom digital printing can be printed directly on it. Printing is a great opportunity to brand your facility or to add advertisements to support sponsors.

Backboards

○ Bakko Backboards

Each panel is 4' wide, 8' or 10' high and weighs 80 to 150 pounds. The Bakko assembly kit holds the panels in a tight, unitized, side-by-side construction. Kits come in traditional flat and single curved styles. All kits are complete. Minimum adequate size is 8' high by 12' wide backboard (3 panels). Attaches to two tennis court fence posts which, on most tennis courts, are spaced 10' apart. Typically a 16' wide (4 panels) and 20' wide (5 panels) backboards require three tennis fence post for attachment. If post are 8' apart a 16' wide backboard can be elegant. 20' wide backboards are very popular, especially in the 10' high series. *May have extended shipping lead times.

SPECIFICATIONS:

- Encased in thick fiberglass and gel coat
- Coated with solar and impact resistant polyurethane paint
- Multiples of 4' wide panels
- 10 Year pro-rated warranty on backboard structure
- 1 Year warranty on paint

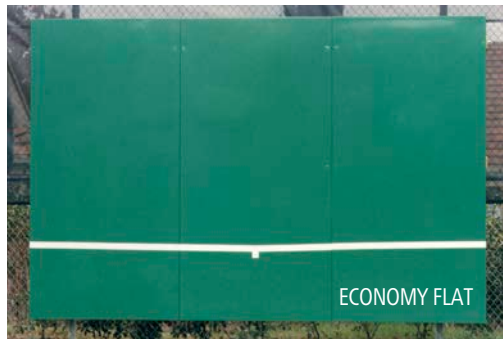

Economy Flat

8'H x 12'W (Item # 34835A)

8'H x 16'W (Item # 34835B)

8'H x 20'W (Item # 34835C)

- 8' high panels, 1.75" thickness
- Sound deadening matrix interior
- Pressure treated 2 x 4's for horizontal supports
- Customer required to drill holes

Slimline Flat

8'H x 12'W (Item # 34836A)

8'H x 16'W (Item # 34836B)

8'H x 20'W (Item # 34836C)

- 8' high panels, 1.75" thickness
- Interior compartmentalized metal frame
- Steel channels for horizontal supports
- Pre-drilled for easy installation



Professional Flat

10'H x 12'W (Item # 34837A)

10'H x 16'W (Item # 34837B)

10'H x 20'W (Item # 34837C)

- 10' high panels, 2.5" thickness
- Heavy, reinforced metal, interior frame
- Sound deadening matrix interior
- Wheel attachments for easy installation
- Steel channels for horizontal supports



Single Curved

10'H x 12'W (Item # 34838A)

10'H x 16'W (Item # 34838B)

10'H x 20'W (Item # 34838C)

- 10' high panels, 2.5" thickness
- Gentle concave curve - top to bottom
- Sound deadening matrix interior
- Wheel attachments for easy installation
- Steel channels for horizontal supports

○ Rally Master

Rally Master Backboards can be used for tennis, lacrosse, soccer, basketball and many other applications. Backboards are available in a vertical (standard) or a sloped option. All backboards measure 10' high and are available in 12', 16' or 20' widths. Backboards can be installed on standard fence post diameters of 2-1/2", 3" or 4" OD. Backboards come with an industry leading 20-year warranty.

When ordering; Vertical style is standard. Please specify if Sloped is desired along with the outside diameter of the fence post the backboard will be installed on.

34852	10' x 12'	Each	500 lbs.
34854	10' x 16'	Each	650 lbs.
34856	10' x 20'	Each	800 lbs.



Rally Master Catch Net

These heavy duty, black, UV stabilized catch nets mount to the top of the backboard with powder coated steel brackets. The net support frame is made of powder coated steel tubing and super-strength corrosion resistant connectors. Nets are 5' high and available in 12', 16' or 20' widths.

34852N	5' x 12'	Each	16 lbs.
34854N	5' x 16'	Each	20 lbs.
34856N	5' x 20'	Each	24 lbs.

○ Panel Construction - Solid-core, 3/4" UV stabilized dense plastic (150 lbs per panel) with the rich green color molded directly into the panel. Net lines are also permanently etched into the panels. Custom colors and custom engraving available.

○ Reduced Sound - Patent-pending vibration dampeners and mounting technique substantially reduce rebound noise. Decibel readings indicate that a tennis ball hitting a Rally Master Backboard is no louder than a tennis ball hitting a tennis racket.

○ Mountings System - Installation is fast and simple with their unique patent pending mounting system. It provides a universal fence bracket that allows the installer to quickly adjust the strut alignment to compensate for fence posts that are slightly bent or out of plumb. System includes all the mounting hardware for a complete installation.

○ Corrosion-Resistant Hardware - Panels are mounted to heavy-duty, galvanized cross braces that are attached to vertical posts using galvanized hardware for unmatched durability.

○ Sizing - Backboards are manufactured in 10' x 4' panels. The minimum size available for purchase is 10' x 12'. There is no limit on length, the only requirement being that the total length is divisible by four feet.



Court Maintenance

○ Straightliner™ Tape Machine

The Straightliner is the fastest and easiest tool to mask court boundaries for painted lines. The tool lays masking tape lines precisely and evenly up to 3" apart. Tape width guides can be changed in seconds. Frame is constructed of black powder coated steel and the tape holder is non-corrosive aluminum. Other features include smooth, non-marking black rubber rollers and comfort grip black rubber handles. The removable 9" pointer guide screws to front of base frame. The standard Straightliner only lays straight parallel lines while the Plus model lays straight and curved. Masking tape is not included.

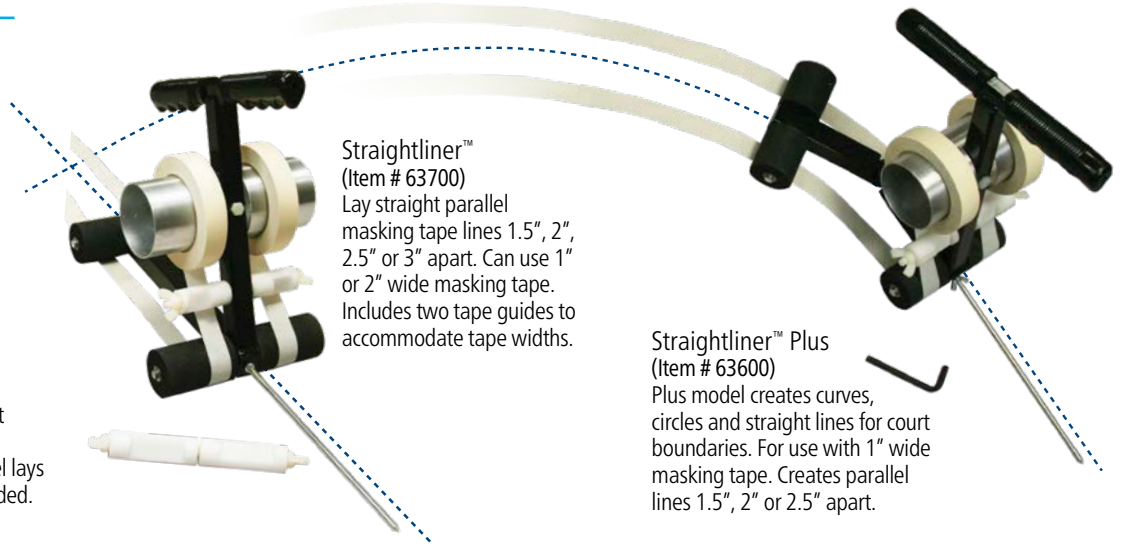

Straightliner™
(Item # 63700)
Lay straight parallel masking tape lines 1.5", 2", 2.5" or 3" apart. Can use 1" or 2" wide masking tape. Includes two tape guides to accommodate tape widths.

Straightliner™ Plus
(Item # 63600)
Plus model creates curves, circles and straight lines for court boundaries. For use with 1" wide masking tape. Creates parallel lines 1.5", 2" or 2.5" apart.

○ Court Dry Water Removers

Court Dry I (Item # 34735)

Includes EZ RR-36

Court Dry II (Item # 34734)

Includes SR-D RR-36

Stop wet weather conditions from interfering with tennis matches or other outdoor court games with the Court Dry. The tough PVA foam roller quickly absorbs and pushes away water. Powder coated stainless-steel frame has a T-socket that securely holds the roller and handle in place during use. Removable roller can easily be substituted for a replacement roller.



Replacement Rollers

E-Z RR-36 (Item # 34603)

Fits most 3' wide water removers. Roller is 5/8" thick polyvinylaldehyde seamless foam with PVC core. Creates an excellent "rolling seal" with the court surface.

SR-D RR-36 (Item # 34742)

Fits most 3' wide water removers. Roller is 3/4" thick seamless polyurethane with a PVC core. Extra thick construction resists tears and separation to provide up to three times more drying power. Ideal for slightly uneven courts.

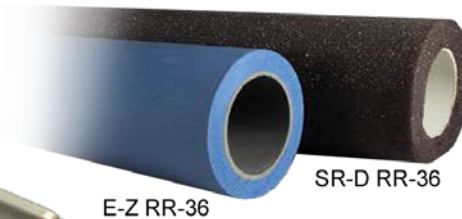

Deluxe Water Broom (Item # 34748A)

Clean more in less time and with 90% less water. Deluxe water broom cleans a 4' wide surface with (9) powerful jets. Designed to be used with a standard 5/8" hose; no special attachments are needed. The rugged aluminum construction will not rust or corrode. Lightweight broom has brass jets and open/close valve with large rubberized grip. Two durable wheels with internal ball bearings rotate freely and make the water broom glide over the ground with minimal effort. Pipe tape included for water tight assembly of water broom.



○ Metal Cooler Stand Set

(Item # 34912)

A functional and attractive court side alternative to water fountains. Complete Cooler Stand set is equipped with a 5-gallon Igloo™ cooler, a cup dispenser along the side and a receptacle.

Court Caddy Set

Green (Item #34745) Black (Item #34744)

A shelf and receptacle combo that keeps personal items in its place and trash where it belongs. The valet tray includes hooks to hang towels and indented holders to eliminate beverage spills and a trash can below for waste. Assembly fits most tennis posts by attaching with a simple hose clamp. Constructed of durable plastic; choose from dark green or black. Receptacle hangs from the court caddy tray attachment.

Court Caddy Basket

Green (Item # 34746) Black (Item # 34746B)

Receptacle hangs on chain link fence or as a replacement for the Court Caddy set. Basket gives players a place to dispose of their trash while on the court.



○ Score Post

(Item # 34732)

Manual tennis score keeper uses tennis balls to score matches with standard scoring allowing for (3) traditional sets or an 8-game pro set. Has an all-metal support that attaches to the net post with quick release hose clamps for easy court change over (no tools needed). Both games and sets won are displayed. Name cards mount on top of mast and are sold separately.

Courtside Accessories



FOREST GREEN



PACIFIC BLUE



BURGUNDY



BLACK

GREEN STRIPE

- Cabana Benches
 - 6' Model - (4' long bench) (Item # 30021)
 - 8' Model - (6' long bench) (Item # 30019)
 - 10' Model - (8' long bench) (Item # 30020)

The 8' Covered Cabana Bench is an attractive way to improve the look and functionality of your tennis or pickleball court. The standard size awning is 6' wide x 8' long but is also available in 8' wide x 8' long and 4' wide x 8' long (so the unit can be placed against a fence). The 3" square heavy-gauge steel frame has a black powder coat finish for ultimate protection. The Durawood bench is made from 3" x 4" plastic composite that is maintenance free and weather resistant. Bench is bolted and welded to the heavy-gauge steel framework to ensure a long life. Choose from three possible 6' long seating configurations –

single flat bench with back rest, two-sided flat bench with back rests and two-sided flat bench without back rests. The all-weather, fade resistant Sunbrella canvas comes with a 5-year fade warranty. Choose from standard colors forest green, pacific blue, burgundy, black, and Forest Green Stripe. Custom canvas colors are available at an additional charge. Bench can be installed "surface Mount" or "Direct Burial". The "Surface Mount" version includes brackets that can be bolted to the surface and the "Direct Burial" method includes poles for burial within a concrete foundation.

- Fence Cabana (Item # 33854)

The Fence cabana is perfect for tennis courts. The awning easily attaches to standard 10' high chain link fences and can be installed in under 30 minutes with two people and simple tools. Fence-mounted awning gable design measures 10' Long x 4' Wide x 2'6" High. Framing is constructed of powder coated, heavy gauge galvanized steel. The frame bolts securely to a fence's top rail with U-brackets. Frame folds at hinges for quick removal and storage. All-weather, fade resistant Sunbrella canvas comes with a 5 year fade warranty. Choose from standard colors forest green pacific blue, burgundy, black, and forest green stripe. Custom canvas colors are available at an additional charge.



- Court Numbers (Item # 34756)

Durable dark green plastic court signs with white printing. Signs have pre-drilled mounting holes. Vertical orientation sign measure 8" x 10". Choose from numbers 1 to 20; please specify desired numbers. See Page 43 for Vinyl Court Signs.



- Court Signs

Court Rules (Item # 34872)
 Soft Sole Shoes Only (Item # 34872A)
 Courts Closed for Maintenance (Item # 34872B)
 Please Register (Item # 34872C)
 Please Keep Gates Closed (Item # 34872D)
 Durable dark green plastic court signs with white printing. All signs are horizontal except "court rules". Signs measure 7" x 10" and have pre-drilled mounting holes.



- Classic Umpire Chair
 - Green (Item # 34777)
 - Black (Item # 34778)

The heavy-duty classic umpire chair is made of custom fabricated powder coated steel that will last a lifetime. Choose from standard rust proof green or black finish. Custom painted chairs with logos are available to match your team or facility. Comfortable cushioned seat has removable cushions for storing out of the weather when not in use. Top and bottom weather treated wooden tables offer an easy access storage solution for officials and umpires alike. Smooth wheels will not scuff court surfacing. Optional umbrella is available.

Douglas® Windscreens/SportScreens



All Douglas® windscreen materials are made for all locations and weather conditions. All high-quality material options are UV treated, breathable and mildew resistant for maximum longevity. They are made to withstand the elements while keeping your facilities looking sharp. Choose from premium windscreen fabrics in both vinyl coated polyester (VCP) and polypropylene. Our range of materials include both open and closed mesh fabrics, standard and custom colors and full color digital printing.

Windscreens are available in standard 6 foot and 9 foot heights and in custom heights by request. Screen length is completely custom and made to order to the nearest inch; 60 feet is the maximum recommended length per panel.

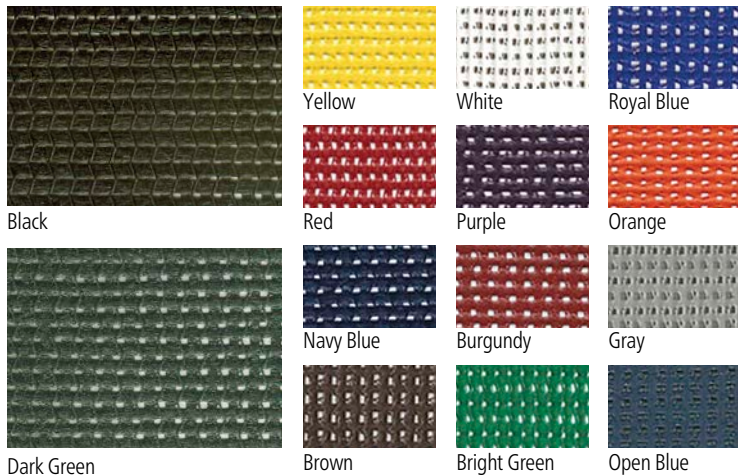

Vinyl Coated Polyester
This versatile and attractive windscreen fabric is durable and boasts great weather resistance. Vinyl Coated Polyester (VCP) screens are available in a variety of colors and custom digital printing and logos can be printed directly on the material.

Fabric: 50% vinyl, 50% polyester, Open (VCP) - 9 x 12 weave
Windbreak: Open - 80%
Weight per square yard: Open - 8 oz.
Tensile Strength: Open - 230 x 200
Colors:
Standard Colors: Dark Green or Black
Additional Colors: Open Tournament Blue, Royal Blue, Red, and Navy Blue
Special Order Colors: Yellow, White, Purple, Orange, Burgundy, Gray, Brown or Bright Green
Warranty: 3-Year Limited

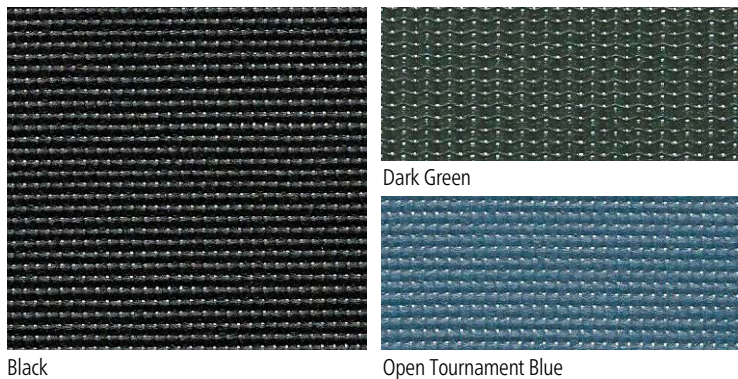

VCP Max™
VCP Max goes one step further by offering maximum tensile strength and visual blockage. At 85% windbreak, VCP Max allows more airflow than closed mesh screens, but provides a better visual background than open mesh screens. This versatile and attractive windscreen fabric is durable and boasts great weather resistance. Custom digital printing and logos can be printed directly on the material.

Fabric: 16 x 17 weave
Windbreak: 85%
Weight per square yard: 10 oz.
Tensile Strength: 395 x 401
Colors: Dark Green, Black, or Open Tournament Blue
Warranty: 4-Year Limited

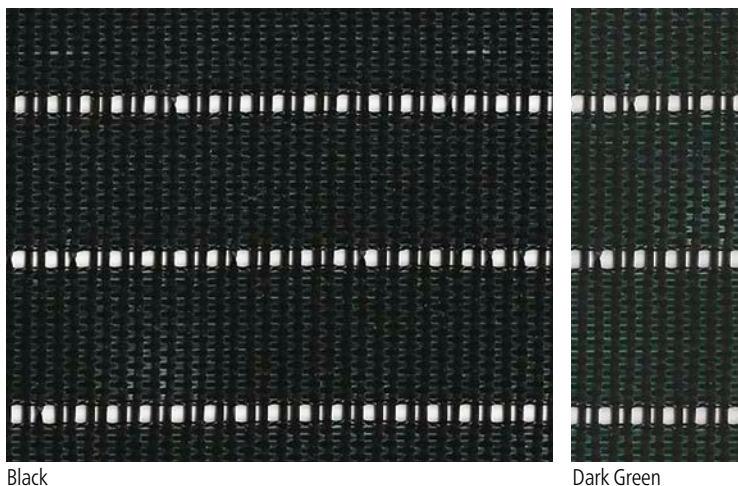

PolyPro™ Plus Premium
This 100% Polypropylene material is a vented open mesh windscreen pattern that allows air to easily pass through while still offering privacy. This open fence screen material puts the least amount of strain on your fence making it ideal for taller fences and windy areas where high airflow is a requirement. PolyPro™ Plus is a highly durable leno weave material that is heat-set so your screens will never shrink or change shape. Weather and UV protection is extruded into every fiber of the Polypropylene windscreen for maximum performance and longevity.

Fabric: 100% polypropylene;
OMP: Open Mesh - 28 x 14 leno weave
CMP: Closed Mesh - 30 x 16 leno weave
Windbreak: Open - 85%
Closed - 95%
Weight per square yard: Open - 7 oz.
Closed - 8 oz.
Tensile Strength: Open - 380 x 185
Closed - 450 x 215
Colors: Dark Green or Black
Warranty: 4-Year Limited



Douglas® Service

With nearly 60 years of experience, we know windscreen from one end to the other. We offer dependable customer service, and we still answer our phones; you will not get a recording during business hours. An experienced representative will be able to answer all your questions. Our team takes pride in quick response times with most online inquiries being answered in less than 24 hours. Our goal is your 100% satisfaction, and we work relentlessly to exceed your expectations.



VCP with 3-Ply Hems



OMP with 4-Ply Hems



VCP with Center Tab (TAB)



OMP with Center Tab (TAB)

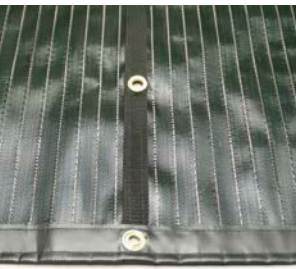

OMP with (CRT)
Center Reinforcement Tape

○ Douglas® Custom Fabrication

All our windscreen fabrics are custom made to order; we custom cut all panels to exact sizes to ensure an accurate fit. As the manufacturer we control every aspect of the production process. Every piece of material goes through quality control checks to ensure accuracy and precision. We pay meticulous attention to detail and guarantee consistent, quality craftsmanship. Every time.

Extra Strong Hems

All panel perimeters are reinforced with durable lock-stitched sewn hems seamed with vinyl. #2 brass grommets are spaced every 12" on panel sides and every 18" along the top and bottom.

VCP and VCP MAX™ fabrics are hemmed with Douglas's 3-ply extra-strong hems. These durable sewn hems are seamed with solid vinyl inserts that are double sewn to 1-1/2 inches wide.

PolyPro™ Plus (OMP) windscreen material is hemmed with Douglas's 4-ply extra-strong hems. These durable hems include solid vinyl inserts as well as an 18 oz. vinyl overlay and are double sewn to 1-1/2 inches wide.

Center Reinforcement

When installing windscreens, center reinforcement is recommended for anti-billowing on all panels that are taller than 6 ft. and where strong winds prevail. Center reinforcement allows the screen to be secured to the middle of the fence with tie wraps or lacing cord attachment. All Douglas® windscreens over 6 ft. in height include a center tab with grommets.

(TAB) VCP and VCP MAX™ fabrics are sewn with 18 oz. black vinyl and grommets are placed every 18 inches to secure the screen to the fence. The reinforcement tab is only visible on the backside of the fence screen for a cleaner installed appearance.

(TAB) PolyPro™ Plus (OMP) windscreen material are reinforced with Center tabs that are double stitched with 3" wide heavy polyester webbing and grommets are placed every 18" to secure the screen to the fence. The center tab grommets are only placed on the webbing and do not go through the fence screen material. This results in a cleaner installed appearance with no visible grommets on the front side of the material.

(CRT) Center Reinforcement Tape Optionally, 9' screens may substitute a Center Reinforcement Tape (CRT). CRT's are double stitched with 1-1/2" wide heavy polyester webbing and grommets are placed every 18". Unlike, standard Center Tabs, with Reinforcement tape, grommets are secured through the fabric and webbing; making the grommets visible on the front side of the fabric. With this method grommets can be laced to the fence with braided rope.



○ Douglas® Custom Graphics

Add digital printing to any VCP fabric and promote team spirit by adding your team affiliation, brand your facility with a company logo or simply add advertisements to support sponsors. Even simple lettering can make an enormous impact on the professional look on a facility.

Our elite printing process allows us to print directly on your material so there's no white back side like other digital printing companies. With the use of quality long lasting UV inks, your printing and logos become part of the material. The UV resistant inks keep their vibrancy for years and no extra coating is needed. Your investment will not crack, peel, or tear like alternative vinyl decals. Our advanced digital printing technology allows for more detailed multi-color capabilities and has a quick turnaround and greater accuracy.

Your digital printing will last the lifespan of the fence screen it is printed on. We back the quality of our digital printing with the same warranty as our windscreen materials.



○ Air Vents

Optional air vents allow air to pass through and help take the strain off your fence and windscreen. Air vents are recommended for screens taller than six feet and where high winds prevail.

Die-Cut (AV) (Item # 21001)

Standard air vents are a die-cut and heat sealed in a half moon shape. Air vents measure 8" wide and are 5" high and are cut out on 10 ft. intervals on center. AV vents are recommended and are only available on vinyl-coated polyester material.

Reinforced (AVR) (Item # 21002)

The Douglas® AVR vents are rectangular sewn cut outs that measure 10" wide x 8" high. These vents are perimeter hemmed with polyester webbing and are placed at 10 ft. intervals on center. AVR vents can be cut into any windscreen material.

○ Tie Wraps

TR-50 7" (Item # 31656)
TR-120 8" (Item # 31657)
Tie wraps are recommended for installation and are sold in packages of 100 quantity. See page 14 for more installation accessories.

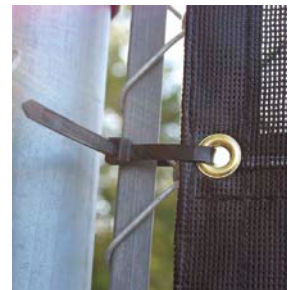

Fence Screening

Privacy Screen

This fence screen is an inexpensive solution for athletic fields, dugouts, bleachers or any other location where privacy or shade is desired. Privacy screen material is lightweight, tear resistant and will not unravel. Construction is 100% high density polyethylene that is weather resistant and UV stabilized. The material will not fade or deteriorate from natural elements and is also resistant to mold and mildew. Privacy Screen can be purchased by the roll to be cut-on-site or purchased in finished 50 foot panels. To maximize strength, an optional reinforced hem with grommets can be applied to the top and bottom edges. These optional hems will reduce the overall roll height. Custom printing is available, contact us with your dimensions for a quote.

Material Specifications:

Construction: 85 – 90% Knit Raschel Fiber
 Content: 100% High Density Polyethylene
 Available Colors: Dark Green, Black, Blue, Brown or Beige

Unfinished Rolls -Cut on site

44" x 150', for 4' fence (Item # 36924)
 68" x 150', for 6' fence (Item # 36928)
 92" x 150', for 8' fence (Item # 36932)

Optional Reinforced Hem (Item # 26932)

Optional reinforced hem with grommets (shown right) can be applied to the top and bottom edges to maximize strength. Optional hems will reduce the overall roll height.

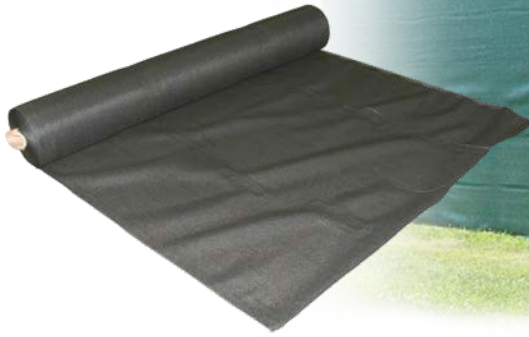

Finished Panels

Panels are finished with perimeter hems and grommets for extra reinforcement. Available in green or black. Shown far right.

68" x 50' Panels

Green (Item # 26928G)
 Black (Item # 26928B)

92" x 50' Panels

Green (Item # 26932G)
 Black (Item # 26932B)

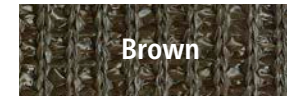

Installation Accessories

These industrial tie wraps have a plastic insert and are recommended for windscreen installation. Sold in packages of 100 quantity.

TR-50P (Item # 31656) 7" Tie wrap, 50 lb. break strength

TR120P (Item # 31657) 8" Tie wrap, 120 lb. break strength

TR-50XL (Item # 31651) 12" Tie wrap, 50 lb. break strength

TR-120XL (Item # 31655) 14" Tie wrap, 120 lb. break strength

TR-120XL (Item # 31652) 17" Tie wrap, 120 lb. break strength



SH-3 (Item # 31663) 3" galvanized "S" hooks

C-3P (Item # 32675) 3" plastic C-snap

BNC (Item # 31600)
 Braided lacing cord 600' reels

BLR (Item # 31601M)
 Braided lacing rope black poly 3/16" 1000' reels 550 lb. break strength

Braided Rope



Outfield Distance Markers

These heavy-duty distance markers hang on your outfield fence with the distance permanently marked. Banners are double reinforced and double stitched around the perimeter with grommets evenly spaced for easy installation. Markers can hang vertically or horizontally, please specify when ordering. Choose from windscreen mesh material or 18 oz. vinyl.

Windscreen Mesh Material

Individual (Item # 36815A)
 Set of 3 (Item # 36815B)
 Set of 5 (Item # 36815C)
 Colors: Dark Green, Purple, Royal Blue, Navy Blue, Maroon, Red, Brown, Orange, Kelly Green, Pacific Blue, Yellow, Gray, or Black

Solid Vinyl Material

Individual (Item # 36816A)
 Set of 3 (Item # 36816B)
 Set of 5 (Item # 36816C)
 Colors: Red, Black, Dark Green, Royal Blue, Kelly Green, Purple, White, Yellow, or Black

Dimensions:

Horizontal: 48" W x 24" H
 Vertical: 24" W x 60" H
 Printed Numbers: 16" H



VCP Windscreen

Solid Vinyl



Baseball & Softball Fence Screens

Fence screens are an invaluable addition to any ballpark facility with multiple uses and advantages. Dress up your ballpark and even solve safety problems with fence screen and accessories:

- Baseball outfield windscreens and fence cap
- Outfield distance markers
- Custom Batters Eye Screen
- Dugout Fronts, Covers and Rail Padding
- Bleacher Wraps
- Bleacher Shade Cover
- Concession & Entrance Fences



Tennis & Pickleball Courts

Windscreens are a great addition to complete any tennis or pickleball court because they offer many benefits including privacy, a solid background, wind reduction and just an overall more enhanced appearance. Unlike other sports facility fences, tennis court chain link fences are typically 10 foot in height. The most common windscreen height that is ordered for a tennis court is 9 foot high and the screen is installed at the top of the fence leaving a foot at the bottom of the fence. This allows for routine mowing and weed eating without worrying about damaging the fence screens. Alternatively, some facilities prefer to order 6 foot high windscreens and center the panels on the 10 foot high fence.



Sport Fields

An invaluable addition to any sports field or stadium with multiple uses and advantages. The primary purpose of windscreen is to reduce wind and noise, increase privacy, gain player focus and gain an overall more enhanced appearance of the facility.



Construction & Business

An ideal way to cover the unsightly appearance of construction sites and redefine an area. Hanging windscreen around a construction site encloses the area, reduces wind, and provides an opportunity for additional branding and advertising.



Custom Bleacher Screens & Enclosures

Adding fence screen panels to the upper safety backs is a great area to enclose to not only block sun and glare but to use as an opportunity to add custom graphics. Meanwhile, bleacher screen enclosures increase safety and can transform an unsightly space into an attractive and useful part of your entire facility. The underside of bleachers often turns into an extra storage area and adding screens can conceal these items along with providing a level of weather protection. Bleacher screens and enclosures are custom made to your specifications from vinyl coated polyester. We can accommodate any custom angle or cut out area to ensure that your custom bleacher screens are a precise fit.

Douglas® Batting Tunnel Frames



○ Douglas® MAX™ Batting Tunnel Frames

Single Frame (Item # 66470)

Double Frame (Item # 66470D)

Triple Frame (Item # 66470T)

The new Douglas® MAX Batting Tunnel Frame is the strongest professional style frame on the market. With this unique design the frame poles can be set for any batting tunnel cage size. The MAX batting tunnel has a strong tension cable support system and only requires corner poles; no center or side support poles are needed to keep the net taught across the length of the tunnel. Less poles means less interference and ball ricocheted during practice. The double frame system is installed with a shared-pole multiple cage design setup. This shared pole design can be setup as a triple, quadruple or custom layout.

These massive 16' direct bury, heavy-duty steel poles are constructed from 8-5/8" OD with a 0.322" wall thickness. Poles are coated with a durable black powder coat finish for maximum protection and weather resistance. Poles are installed 4' deep, allowing a maximum installed net height of 11'6". Welded steel tabs are placed at the top of each pole to secure the net cable tensioning system. Frame poles are installed at the desired tunnel net width and at least 5' longer for the length.

The tension cable support system consists of 1/4" galvanized aircraft cable with a 6,100 lb. break strength. Three tension cables are ran the length of the tunnel to support the net. All net-to-cable connections are constructed from long lasting steel. All of the necessary hardware components including quick links, turnbuckles, cable clamps and carabiner clips are provided. Batting tunnel nets are sold separately – choose the size that suits your needs best.

Douglas® MAX Batting Tunnel Frames include a 7-Year limited warranty with a proper installation and normal, intended use.



○ MAX™ Outdoor Batting Tunnel Cable Hardware Kit (Item # 66205) Poles are not included.

This batting tunnel kit is the complete tension cable support hardware system included with the MAX batting tunnel frame. It is ideal if you have existing poles or are installing your own poles and need a tensioned kit for your batting tunnel net.

Kit Includes:

- 300' 1/4" Cable
- (8) TB-12 Turnbuckles
- (20) Cable Clamps
- (4) 1/2" x 9/16" Eyebolts
- (4) Locknuts
- (2) 3/8" Quicklinks
- (100) 8 mm Spring Links





○ Douglas® Batting Tunnel Frame

Single Frame (Item # 66216)

Double Frame (Item # 66216D)

Triple Frame (Item # 66216T)

The classic, durable Douglas® Batting tunnel frame has withstood the test of time and been manufactured for over 30 years. With the Douglas® Batting Tunnel frame your poles can be set at your desired length and can also be adjusted to fit custom net widths. Standard batting tunnel lengths are 55'/70'/75' and widths are 12'/14' wide. The unique frame design allows for the tunnel's net to easily be adjusted at any time after the initial installation. The double and triple frame system is installed with a shared-pole multiple cage design setup, eliminating the need for extra poles and ground footings.

This heavy-duty frame is constructed using six, 14", 4" square, heavy-duty steel poles. A black, baked on powder coat finish on the steel frame provides the ultimate weather resistance and protection. The width of the end frames are reinforced using 2-3/8" OD, heavy-duty 7-gauge galvanized steel crossbars used to attach the steel cables for attaching the net. Crossbars feature Allied's zinc Flo-coat galvanization process for maximum protection. Frame poles are installed with 4" square 24" aluminum ground sleeves, allowing a maximum installed net height of 12'.

The cable support systems consists of 1/4" galvanized aircraft cable with a 6,100 lb break strength. Cables are ran the length of the tunnel and attached to the crossbars to support the net. All net-to-cable connections are constructed from long lasting steel. All of the necessary hardware components including quick links, turnbuckles, cable clamps and carabiner clips are provided. Batting tunnel nets are sold separately – choose the size that suits your needs best.

Douglas® Batting Tunnel Frames include a 5-Year limited warranty with a proper installation and normal, intended use.



Douglas® Tunnel Nets

All Douglas® Tunnel nets are 1-3/4" knotted polyethylene square mesh making it easier to hang and provides a cleaner appearance. Knotted netting boasts a high overall strength rating making it superior for direct impact applications.

Our Polyethylene netting offers a high UV and weather protection. Polyethylene naturally doesn't absorb water so it's mildew resistant and retains a high percentage of its strength over an extended period of time.

Choose from our standard high quality batting tunnel nets or Douglas® can also custom fabricate to your exact size specifications. Custom tunnels are manufactured with reinforced vinyl or rope borders on top and centers.

○ Douglas® #42 Knotted Twisted HDPE Polyethylene Tunnel Nets

BT #42 Netting:

(#42 Knotted; 3-Year Warranty)
 12'H x 12'W x 35'L (Item # 36042)
 12'H x 12'W x 55'L (Item # 36048)
 12'H x 14'W x 55'L (Item # 36046)
 12'H x 12'W x 70'L (Item # 36043)
 12'H x 14'W x 70'L (Item # 36045)
 12'H x 14'W x 75'L (Item # 36049)

This twisted polyethylene netting is a #42 gauge in with reinforced sewn rope borders around the perimeter. Corners have 6' rope tails and sewn loops making it easier to hang. Choose from six standard sizes. All nets include a convenient overlap style entry door. 3 year warranty.



○ Douglas® Knotted Braided HDPE Polyethylene Tunnel Nets

Professional, BT-PRO 3.5

(3.5 mm Knotted; 4 Year Warranty)
 12'H x 12'W x 55'L (Item # 36038)
 12'H x 14'W x 55'L (Item # 36036)
 12'H x 12'W x 70'L (Item # 36033)
 12'H x 14'W x 70'L (Item # 36035)
 12'H x 14'W x 75'L (Item # 36039)

This strong, knotted solid core Polyethylene netting is a thick 3.5 mm braid. The borders and the perimeter of the tunnel net is secured with a 5/16" rope border for easy hanging. Choose from five standard sizes. All nets include a convenient overlap style entry door. 4 year warranty.



○ Hitting Station Systems

55' Model – (3) Hitting Stations (2 poles) (Item # 66255)
 70'/75' Model – (4) Hitting Stations (3 poles) (Item # 66270) (specify 70' or 75' when ordering)
 This "stand-alone" system can be placed alongside your batting tunnel/cage for players to use before or after their turn in the cage or anywhere you need 3-4 hitting stations. Frame is constructed from 4" square heavy-duty steel poles with a black powder coat finish. Pole system is an attractive addition to any facility. High-impact netting is constructed of black #42 nylon. Netting is 1-3/4" square mesh with a reinforced rope border. Netting is extruded to permanently resist weather, ultra violet, mold and mildew. High tenacity nylon boasts a 435 lb. break strength to easily withstands and absorb heavy ball impact. Netting is hung from 1/4" galvanized steel cable. Complete system includes ground sleeves and everything needed to install. Choose from two standard sizes; custom lengths are available.



○ Tunnel Accessories

Baseball/Softball Impact Nets

12'H x 14'W (Item # 36060)
 12'H x 12'W (Item # 36062)

Use as a Net Saver behind the batter to protect and add a buffer to your tunnel net or position as a Net Divider to create two short toss stations inside your tunnel.

Netting panel is made from black 3.5 mm knotted braided HDPE netting. Netting is UV and weather treated. Netting is 1-3/4" mesh and boasts a 325 lb. break strength. Perimeter is finished with a durable rope border to simplify installation and reduce sag. Netting is 12' high in either 12' or 14' widths.

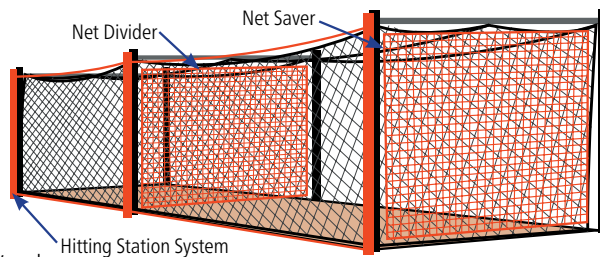

Tunnel Frame Protective Padding

(Item #39032)
 Fitted pole pad is 72" high and is designed to fit 4" square poles. Attaches with Velcro straps. High impact foam padding is 2" thick. All weather vinyl is UV resistant and available in dark green, black, royal blue, navy blue, or red.



Vinyl Hitting Backdrop

Solid Black (Item # 26460)
 Black With Pitching Target (Item # 26460T)
 An economical way to protect your tunnel net and provide a visual backdrop for pitchers. Protective backdrop measures 6' x 5' and is constructed of black heavy 18 oz./sq. yd. vinyl. Reinforced perimeter hem with grommets C-snaps are included for hanging onto tunnel net. Available with optional white printed hitting target.

○ Installation Accessories

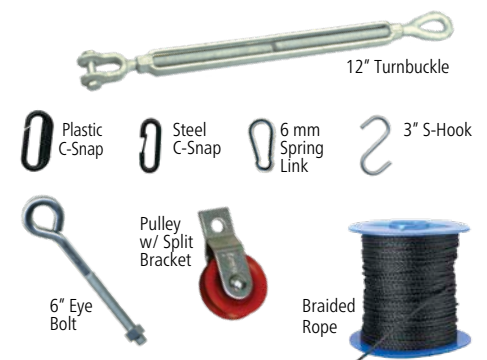

- 1/4" Galvanized Cable (Item # 34728)
- 1/8" Galvanized Cable (Item # 15102)
- 1/4" Cable Clamp (Item # 34725)
- 1/8" Cable Clamp (Item # 34726)
- 12" Turnbuckle (TB-12) (Item # 34724)
- 6" Turnbuckle (TB-6) (Item #36986)
- C-Snap, Black Plated Steel (Item # 32670)
- C-Snap, Black Plastic (Item # 32675)
- 8 mm Spring Link (Carabiner) (Item # 36000)
- 6 mm Spring Link (Carabiner) (Item # 32680)
- 3" Steel S-Hook (Item # 31663)
- 3/16" PolyPro Braided Rope (1000' Roll) (Item # 31601M)
- 6" Eye Bolt (Item # 34730)
- Pulley with Split Bracket (Item #34721)

Douglas® Indoor Batting Tunnels



Douglas® Indoor Tunnel Kits

Kits includes all hardware needed to setup and hang a batting tunnel net from side walls inside a gym or training facility.

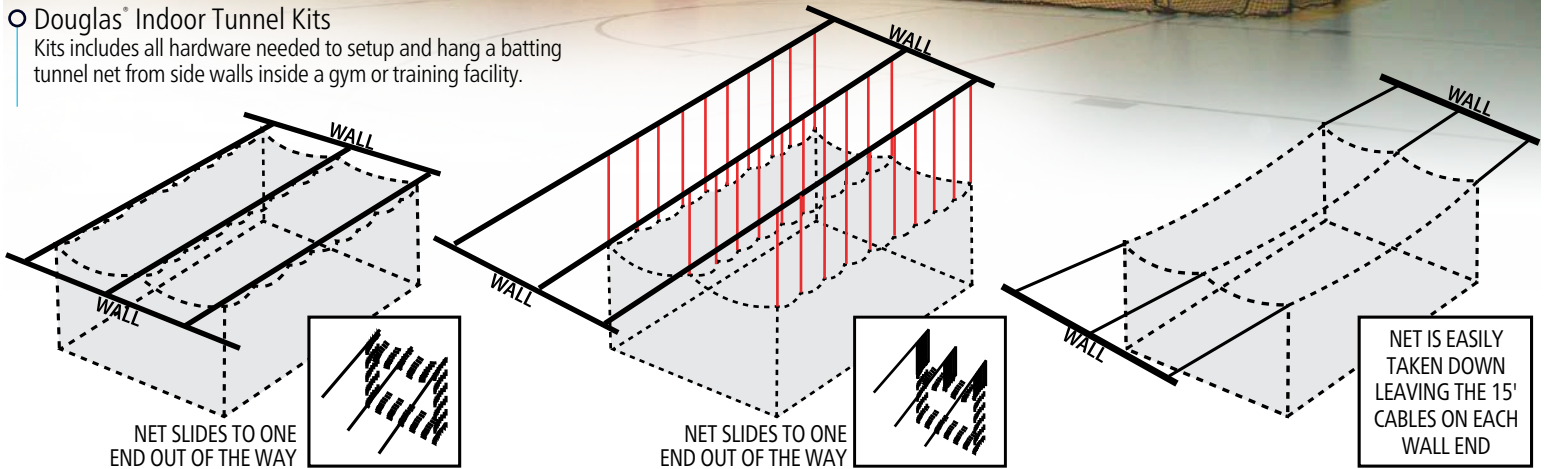

Accessory Cable Hardware Kit

- Kit Includes:** (1) – Spool, 500' 1/4" Cable
(Item # 66213) (70) – Steel C-Snaps
(70) – Split Bracket Pulleys
(6) – Turnbuckles
(12) – 1/4" Wire Cable Clamps
(6) – Eyebolts

Ceiling Suspension Kit

- Kit Includes:** (1) – Spool, 500' 1/4" Cable
(Item # 66219) (2) – Spools, 1,000' 1/8" Cable
(60) – 1/8" Wire Cable Clamps
(12) – 1/4" Wire Cable Clamps
(6) – Turnbuckles
(6) – Eyebolts
(70) – Steel C-Snaps
(30) – Split Bracket Pulleys

Batting Tunnel Tensioning Kit

- Kit Includes:** (6) – Eyebolts
(Item # 66200) (6) – 8 mm Spring Link Clips
(6) – 3/8" Spring Link Clips
(6) – Cables 15' long
(3) – 50' Pieces of High Strength Braided Hoisting Rope 3/8"
(3) – Cam Lock Pulley Systems
(3) – Swivel Clamps



Installation Accessories



- 1/4" Cable, Galvanized (Item # 34728)
1/8" Cable, Galvanized (Item # 15102)
1/4" Cable Clamp (Item # 34725)
1/8" Cable Clamp (Item # 34726)

- 12" Turnbuckle (TB-12) (Item # 34724)
6" Turnbuckle (TB-6) (Item # 36986)
C-Snap, Black Plated Steel (Item # 32670)
C-Snap, Black Plastic (Item # 32675)

- 8 mm Spring Link (Carabiner) (Item # 36000)
6 mm Spring Link (Carabiner) (Item # 32680)
3" S-Hook, Steel (Item # 31663)
6" Eye Bolt (Item # 34730)

- Pulley with Split Bracket (Item # 34721)
3/16" Polypro Braided Rope (1000' Roll) (Item # 31601M)

Protective Screens

Protective screen frames are constructed from standard 1.5" powder coated steel. These compression bolt together frames give the protective screens both stability and strength to stand up to the punishment of batting practice and fielding drills. Gussets are added on each leg to ensure durability and longevity. The heavy duty, UV weather treated #60 knotted net slips over the frame pillow-case style to offer double protection and has proven to protect and last for years.

Varsity L-Screens

The L-Screens are the perfect choice for both fielding and batting cage use. The stable and tough frames offer the security and durability to withstand the beating delivered on the field or in the cage.



L-Screen
(Item # 36460)
The 7' x 7' frame has a 3' x 3' cutout that offers ample space to throw behind and gives the pitcher a comfortable feel while throwing batting practice.



Mini L-Screen
(Item # 36461)
The 7' x 5' has a 3' x 3' cutout and still offers ample space to throw behind and provide protection during batting practice. The Mini size takes up less space in a cage or on the field.

Full Padding (Item # 29210)

Creates a great baffle on L-screens to help prevent balls from ricocheting. Must provide measurements if not ordering with a frame. Specify Color.



Varsity Field Screens

Great for baseball or softball use, these field screens are versatile and can be used for almost any form of protection on the field and on the sidelines. Although its primary design is to protect fielders during drills, it is also great for use as a catcher's back stop, inside batting cage tunnels as a divider or backdrop and also to hang pitcher's targets.



7x7 Field Screens
(Item # 36463)

The 7' x 7' versatile size frame opens the door to endless uses and offers ample space for protection.



8x10 Field Screens
(Item # 36464)

The 8' x 10' frame offers a larger size to protect fielders and coaches while working infield and outfield practice drills.



10x10 Field Screens
(Item # 36465)

The oversized 10'x10' frame offers maximum protection for the bases during fielding drills and station work.



6x4 Mini Safety Screen
(Item # 36468)

The 6' x 4' portable size screen still offers protection for the pitcher while maintaining a manageable size that fits in the bed of a truck without needing to be disassembled.

Varsity Sock Net Screen

(Item # 36466)
The 7' x 7' frame has a hitting target area that measures 53" wide and 49" high. Great for baseball or softball use, the Field Screen is versatile and can be used for almost any form of protection on the field and on the sidelines.



Varsity Softball Screen

(Item # 36467)
The 7' x 7' screen has a 30"H x 24" W cutout that is perfectly positioned to maximize both the protective area behind the screen and the area to pitch through. The cutout is 21" from ground; which is the optimum height for most fastpitch pitching machines.



Pro Ball Cart

(Item # 36676)
Ball Cart holds up to 280 baseballs and 190 softballs. Large 10" airless wheels make rolling easy. This durable product is a perfect match for years of batting practice on the field and large enough to last long batting practice sessions. Easy to assemble.



Varsity Wheel Kit

(Item # 36469)
This particular product is used for all 1.5" OD frames. They are equipped with never go flat airless tires. Wheel kit is easy to put on and take off.



Replacement Nets

L-Screen 7' x 7' (Item # 36450)
7' x 7' (Item # 36449)
Sock Net 7' x 7' (Item # 36457)
Softball Pitching Net 7' x 7' (Item # 36462)



Replacement slip-on nets for protective screens are made from heavy-duty 3.5 mm knotless HTPP. Netting is 1-3/4" square mesh and boasts a 325 lb break strength. Netting is UV and weather treated. The slip-on style net simply slides over the frame and only require lacing cord at the bottom to close the net. Custom size nets are available.

Baseball Outfield

Professional Foul Poles
 20'-12' wing (Item # 36650)
 15'- 8' wing (Item # 36650A)
 12'- 6' wing (Item # 36650B)
 Ground Sleeves
 (Item # 36650GS)
 Addition to any ball field, this pair of Professional Foul Poles clearly marks the difference between a home run and a foul ball. Players, fans and officials can make the call in any conditions, day or night, thanks to the bright yellow coating and expanded metal wings. Heavy-duty, powder coat steel means the poles are built to withstand harsh weather and line-drive home runs. Constructed of heavy-duty 3.5" OD 13 gauge steel pipe with an 18" wide expanded metal wing. Bright yellow makes it easy to track the ball as it crosses past the poles.



Poly-Cap
 250' roll (Item # 36966/BLK)
 100' roll (Item # 36960/BLK)
 Package 100 ties (Item # 36968/BLK)
 Poly-cap is UV treated and is available in yellow or black. Improves safety and makes any field more attractive. Comes pre-slit and ready to install. Yellow or black 18" UV tie-raps are recommended every 3' to secure poly-cap to fence. 2 Year warranty. Please specify desired color when ordering.

Poly-Cap Installer Tool
 (Item # 36969)
 Install 100' in less than 10 minutes!



Aluminum Foul Poles
 15' Above Ground, 7' Wing (Item # 36651)
 20' Above Ground, 12' Wing (Item # 36652)
 30' Above Ground, 22' Wing (Item # 36653)
 40' Above Ground, 32' Wing (Item # 36654)
 Foul Poles are manufactured from 4"(15' and 20') or 6.625"(30' and 40') outside diameter aluminum pipe and are available in standard above ground heights of 15', 20', 30' and 40'. All foul poles are powder coated yellow, utilize ground sleeves with corresponding caps or a base plate mounting system for a semi-permanent installation, and are available with or without a wing. Standard wings start 8' above finished grade and consist of 1/8" stamped aluminum sheet with double reinforced bends making them much more durable and longer lasting than weaker competitive mesh products. Custom foul pole heights and/or wing sizes are available, upon request. Please specify ground sleeve or plate mounted when ordering. Yellow is standard; white or orange is also available upon request.

Fence Guard
 Eliminate chain link injuries and add some color to your park. Our premium quality protective fence covers offer the highest level of player protection. Don't be fooled by low cost, thin walled look-a-likes, demand the best! The professional teardrop shaped profile is easy to install with just one person. Exterior grade UV resistant polyethylene construction is maintenance free and is designed to be the longest lasting fence cap available. Pre-drilled every 24" and includes ties for securing to the fence. Available in (3) grades of durability with (6) colors to choose from. Comes in 7' sections; in 84' cartons only.



Standard
 (Item # 36984)
 3 Year limited warranty
 .07 wall thickness
 2-5/8"W x 4"H x 7'L.
 Yellow, Forest Green, Red, Blue, Orange, Black, or White.

Premium
 (Item # 36982)
 5 Year limited warranty
 .10 wall thickness
 3"W x 4-1/2"H x 7'L.
 Yellow, Red or Blue.



Douglas® Ballpark Netting

1-3/4"
Mesh

○ #12 Knotted UHMPE Dyneema

Major league professional backstop netting provides maximum protection with maximum viewing. This strong netting is only 1.4 mm with a 94% visibility rate. Twisted knotted Dyneema is an ultra high molecular weight polyethylene (UHMPE). Material is treated for maximum UV and weather resistance. Netting perimeter is finished with a 1/4" solid braid sewn rope border. Rope border has 1,500 lb break strength.

1-3/4" SQ Mesh

Medium weight, 308 lb. break strength; 94% visibility

(Item # 26012)

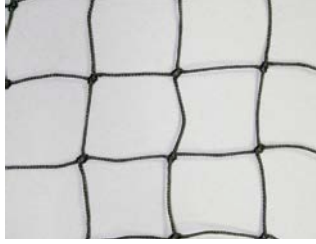

○ #42 Knotted Ultra HDPE

Premium Twisted Knotted Ultra High Density Polyethylene is made with specialized treatment to provide the strength of nylon with the UV and weather resistance of polyethylene. This high impact backstop netting is 2.4 mm thick with a break strength of 392 lbs. Netting perimeter is finished with a 1/4" solid braid sewn rope border. Rope border has 1,500 lb. break strength.

1-3/4" SQ Mesh

High Strength, 392 lb. break strength

(#26142)



○ Twisted Knotted Nylon

This high tensile strength black nylon netting is ideal for medium to high impact backstop and protective screen applications. Outdoor netting has been treated for UV and weather resistance. Netting is finished with a rope border which allows for a simple and easy installation.

1-3/4" SQ Mesh with Rope Border

LIGHT WEIGHT

#18 Black 194 lb. break strength (Item # 36098A)

#21 Black 237 lb. break strength (Item # 36099A)

MEDIUM WEIGHT

#36 Black 345 lb. break strength (Item # 36099B)

HEAVY WEIGHT

#42 Black 435 lb. break strength (Item # 36099C)

#48 Black 472 lb. break strength (Item # 36099D)

#60 Black 720 lb. break strength (Item # 36099E)

#72 Black 862 lb. break strength (Item # 36099G)

#96 Black 1,112 lb. break strength (Item # 36099F)



○ Knotless Polypropylene HTPP

This premium high tenacity Polypropylene (Pylon) netting offers the most longevity and durability. Pylon netting is a great all-purpose netting with an attractive appearance and good strength. Outdoor netting is treated and extruded through the fibers for maximum weather and UV resistance. Netting can be finished with a rope or vinyl border. A rope border offers a simple and easy installation. The vinyl edging provides the netting with added strength while keeping the nets shape. The reinforced, double stitched vinyl also gives the net a sharp appearance. Optional brass grommets can be added and are placed every 18".

3.0 mm; 1-3/4" SQ Mesh

Medium Weight, 250 lb. break strength

Black, Sewn Rope Border (Item # 22260R)

Black, Tape Bound with Grommets (Item # 22260)



Douglas® Backstop & Netting Systems



- Douglas® Backstop Netting Systems
 - Standard System with Poles (Item # 66800)
 - Suspended System with Poles (Item # 66805)

Black Coated Poles w/ Lifting Tabs
 6-5/8" OD x 0.25" Wall (Item # 36282)
 8-5/8" OD x 0.322" Wall (Item # 36283)
 10-3/4" OD x 0.365" Wall (Item # 36284)
 12-3/4" OD x 0.375" Wall (Item # 36286)

Take the guess work out of setting up your own backstop system and get a complete kit with all of the cable, hardware and custom netting that you need for your unique facility. The Douglas® Backstop Netting Systems are available with or without poles and provide a complete professional looking backstop setup. Choose from the Standard Cable System (Pole-to-Pole) or the Suspended Cable System (Tie-Back) which provides more of an unobstructed view.

Complete systems include poles, hardware and high impact backstop netting. Heavy-duty poles are finished with a black powder coat finish and are available in 4 sizes. Installation hardware includes 1/4" galvanized aircraft cable with 6,100 lb. breaking strength, heavy-duty eyebolts and turnbuckles as well as the appropriate cable clamps and carabiner clips. The Douglas® Professional #12 Knotted Dyneema 1-3/4" SQ mesh netting is recommended. Other netting can be substituted.

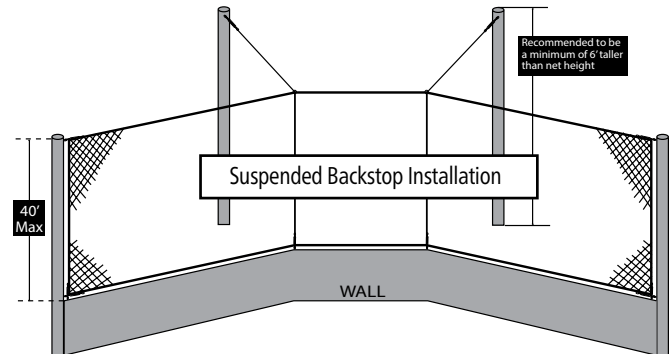
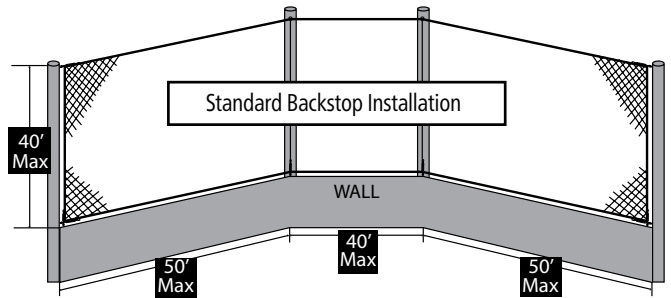
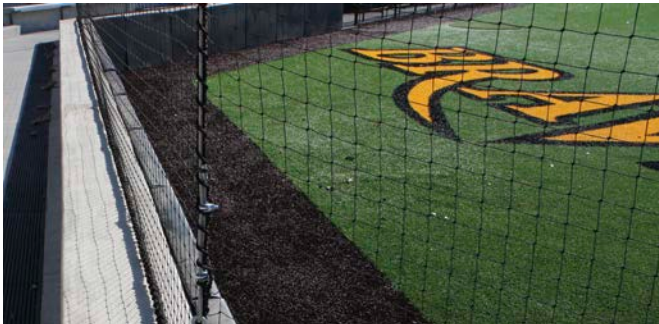

- Douglas® Backstop Cable Hardware Kits
 - Standard Installation (Item # 66290)
 - Suspended Installation (Item # 66295)

These complete backstop cable system kits provide all the hardware needed to install a professional looking backstop with your new or existing poles. Hardware includes 1/4" galvanized cable, turnbuckles, cable clamps, eye bolts and carabiners. Custom netting is sold separately, poles are not included.

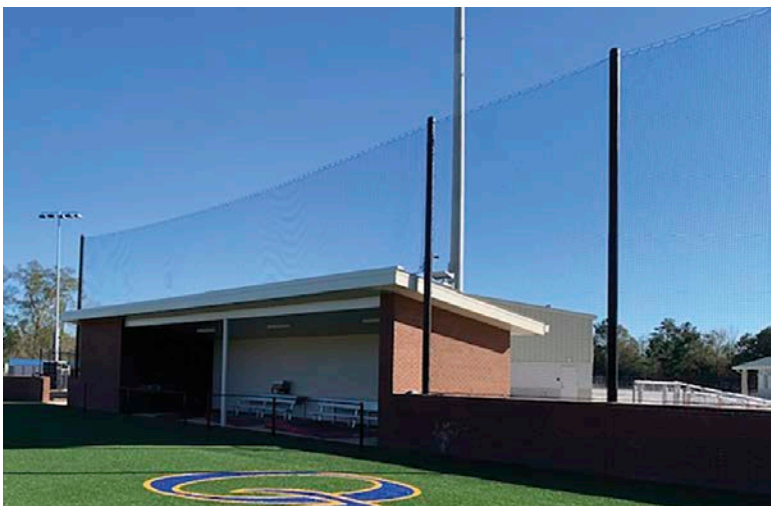

- Douglas® Complete Netting Systems (Item # 67200)
- Complete your facility with Douglas® permanent netting systems that are designed to stop balls, prevent property damage and provide player and spectator safety. All systems include high-quality netting, poles, and all the hardware needed for a complete installation. These netting systems are ideal for multi-sport facilities where multiple games or practices are going on simultaneously. Systems are designed to meet your specific needs and can be custom fabricated to virtually any size.

Permanent Netting Systems come with everything you need including heavy-duty steel poles, netting, high-tension cable and hardware. Permanent systems are great for baseball/softball protective netting as well as barrier netting for multi-sport facilities. Any height can be accommodated up to 40' and custom sizes are available.

Quality outdoor netting is UV and weather resistant and is custom made for your project and application. Choose from various netting mesh sizes including 1-3/4" SQ Mesh, 1-1/2" SQ Mesh, 4" SQ Mesh and also 7/8" SQ Mesh.

Douglas® Pro-Series Outdoor Stadium Wall Padding



○ Protect your players with durable, Douglas® Pro-Series Outdoor Protective Stadium Wall Padding. This professional grade wall padding is perfect for baseball and softball field walls and backstops, as well as football stadiums and other venues. Maximum panel size is 8' high by 4' wide. The standard foam is a 3" thick open cell high density polyurethane (HDPU). Pad covering is 18.5 oz. UV and weather resistant vinyl with many color options. Custom digital graphics and logos can directly be applied to padding vinyl for branding. Wood backing is 3/4" thick exterior marine grade plywood. Aluminum z-clip channel attachments are used for concrete, block, or wood walls. Bolt and backup plate installation is available for chain link fences.



○ Douglas® Custom Graphics

Our vinyl fabrics are digitally printed with our high-quality UV digital printing process. Our elite printing process allows us to print directly on our material so there's no white back side like other digital printing companies. Your printing and logos become part of the material. Your investment will not crack, peel or tear like vinyl decals. Our digital printing allows for more detailed multi-color capabilities and has a quick turnaround and greater accuracy.

- 18 oz. UV and weather resistant vinyl
- 3" High impact polyurethane foam
- 3/4" Exterior marine grade plywood backing
- Aluminum z-clip attachments for walls
- Bolt and backup plates for chain link fence
- Digital graphics are available



DARK GREEN	KELLY GREEN	BLACK	ROYAL BLUE	NAVY BLUE	LIGHT BLUE	RED	MAROON
PURPLE	YELLOW	ORANGE	TAN	BROWN	GRAY	CHARCOAL	OTHER COLORS AVAILABLE BY REQUEST

○ Douglas® Dugout and Guard Rail Padding (Item # 29217)

Douglas® guard rail pads are a wraparound style that are custom fabricated using 1" thick high-density foam cores. Foam is 1" prime polyurethane 100+ ILD for ample cushioning protection. Foam is encased in durable 18 oz. vinyl that has a UV and weather protection coating for long term resistance against the elements. Pads are sold in up to a maximum 10' in length and are sold per linear foot. Perimeter vinyl flap edging is 1.5" wide and is double sewn with heavy duty #2 brass grommets spaced every 6". Standard size pads are manufactured to fit up to a 2" diameter pipe. Dugout guard rail padding is typically installed with UV protected tie raps or lacing cord. Custom sizes are available to fit any diameter pipe.



○ Douglas® Dugout Protective Netting

Add Douglas® custom fabricated dugout protective netting to your open guard rail dugouts to enclose the area and add protection from errant foul balls. Our black square netting offers a clean professional appearance. Any of our baseball netting will work but most common is Pylon 3.0 mm Knotless HTPP 1-3/4" SQ Mesh Black Netting and #36 Twisted Knotted Nylon Black 1-3/4" SQ Mesh. The 3 mm Knotless offers a clean look and offers ultimate weather protection, while Knotted Nylon provides a stronger break strength at 365 Lbs. All Netting is bound with rope border which allows for a simple and easy installation. Netting can be secured to the dugout with UV protected tie raps or lacing cord. Dugout Protective Netting is sold per square foot, and any custom height or length is possible.



○ Douglas® Custom Graphics

Add digital printing with our high-quality UV digital printing process. You can choose to print on the entire pad or just the front face of the pad to advertise your team's name or logo. Recommended front face print area height is only 3"-4".



○ Logo Vinyl Rail Wraps (Item # 29219)

A low cost solution for changing sponsors, advertisers or just to cover up existing damaged guard rail covers. Simply secure vinyl rail wraps with plastic tie raps. Material is 18 oz. UV and weather resistant vinyl. Virtually any color and design is available with digital printed graphics.



Douglas® D-Pro™ MAX Basketball Systems

○ Max Clearview Backboard

Our durable, NBA regulation size "clear view" tempered glass backboard has an aluminum perimeter frame supported by a welded steel back frame. Unlike traditional "H Frame" backboard supports, the reinforced galvanized steel extension arms attach directly to the perimeter frame, allowing for the preferred, professional "clear view" appearance. Our tempered glass board is a full 1/2" thick which is the same used at all competitive levels such as the NBA and NCAA.

○ Pressure Flex Breakaway Goal

Constructed of robust steel with a CSPC compliant powder-coat finish and featuring a 5/8" thick, 18" steel rim, and a double spring pressure flex breakaway mechanism, our recreational breakaway goal attaches to the MAX clear view backboard with a double reinforced steel back plate. Featuring unique hidden net attachment style hooks along the inside of the hoop, our pressure breakaway goal will withstand the weight of even the most aggressive slam dunks.

○ Reinforced Extension Arms

A corrosion-resistant, 1-9/16" x 3-1/8" top reinforced extension arm and lower 2" x 4" reinforced extension arm attach to the outer perimeter and the base of the backboard frame allowing for the preferred clear view style. Arms overhang the regulation 4' and provide increased stability and strength and ample room for play.

○ Galvanized Steel Pole

Through decades of design and testing, we have manufactured our one-piece construction galvanized steel pole, equipped with double welded base gussets, with the optimal specifications to minimize shake and vibration. Constructed from 6" square galvanized steel with a 3/16" wall thickness, the system is built to handle rugged play in the toughest conditions.

○ Stress Free Height Adjustment

Effortlessly adjust the goals' height anywhere from 5-1/2' to 10' with two lift-assist, pre-assembled cylinders. The lift-assist ingenuity counterbalances the weight of the backboard so even a small child can raise and lower the goal. The smooth operating adjustable height crank assembly has an easy-to-read gauge and the stainless steel handle is removable to prevent unwanted tampering.

○ Easiest Installation Process

A robust anchor system allows for easy and accurate leveling during installation. All systems are set in a structurally sound 4' deep concrete footing providing a safe and steady base. J-bolt anchor system permits you to dismount your basketball system and move to a new location.

○ Protective Padding

Form fitted pole and base padding are manufactured with durable black all-weather vinyl that is UV and all weather resistant. Dense foam padding is 2" thick for maximum impact protection. Padding secures in the back with sewn-in overlapping Velcro straps. Sleek, molded vinyl backboard padding offers maximum player protection while not interfering with game play. Backboard padding is pre-installed for your convenience.

○ All Weather Protection

Blazing summers, drizzly springs, and icy winters are no match for the ultimate weather protection of the D-Pro™ MAX Basketball System. Our team immerses our steel in a bath of molten zinc to produce a corrosion resistant, multi-layered coating of zinc-iron alloy and zinc metal, preventing rusting and chipping, while providing ultimate weather protection against the elements. All of the fastening hardware is made from stainless steel to ensure your system maintains its structural integrity.

○ Limited Lifetime Warranty

With over five decades of experience manufacturing elite sports equipment and great customer service to help you identify and solve problems, we stand behind our systems and guarantee a lifetime of dunks. Replacement parts are always readily available, so you never have to miss a minute of playtime.

 **-PRO™** ADJUSTABLE SERIES

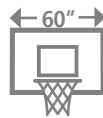

645 MAX
CLEARVIEW
42" x 60" BACKBOARD
(Item # 69660)

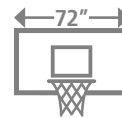

646 MAX
CLEARVIEW
42" x 72" BACKBOARD
(Item # 69672)

Outdoor Basketball Padding



435 MAX

CLEARVIEW

42" x 60" Polycarbonate
(Item # 69635)

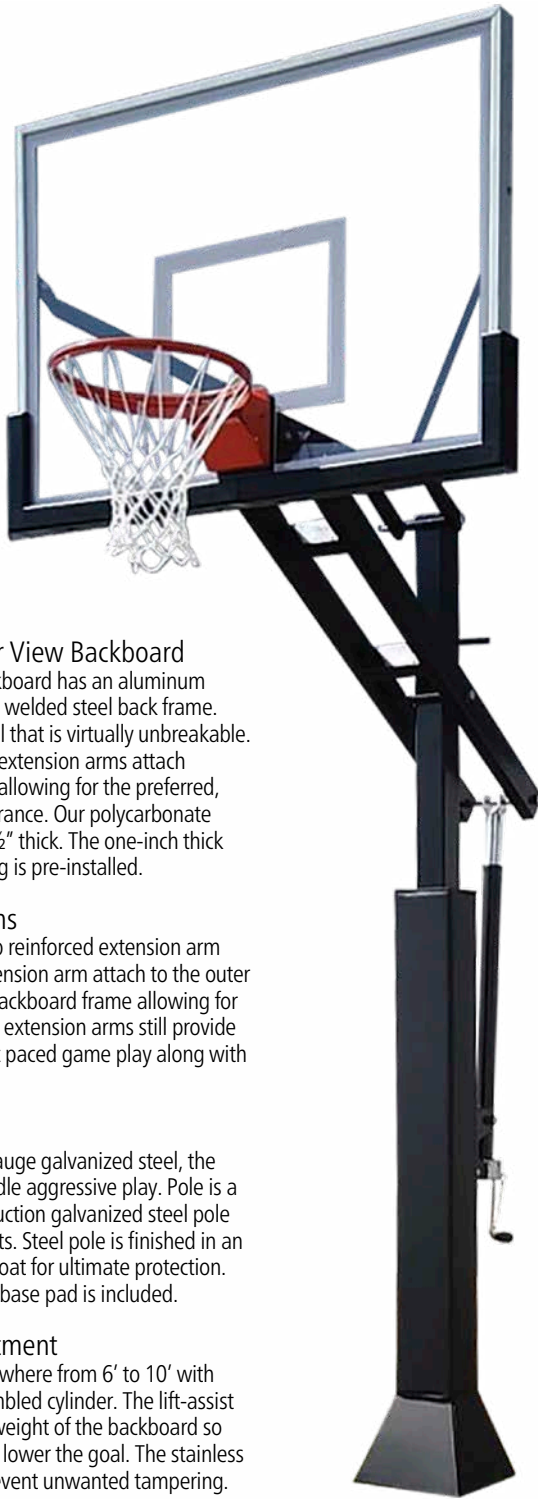

Douglas® D-Pro™ 435 MAX is designed for durability and playing performance at an affordable price for home owners and recreational establishments. The 435 Model is a smaller version with most of the same quality features as the standard models.

MAX Polycarbonate Clear View Backboard

Our durable Polycarbonate backboard has an aluminum perimeter frame supported by a welded steel back frame. Polycarbonate is a clear material that is virtually unbreakable. The reinforced galvanized steel extension arms attach directly to the perimeter frame, allowing for the preferred, professional "clear view" appearance. Our polycarbonate board is 60" x 42" and is a full ½" thick. The one-inch thick molded vinyl backboard padding is pre-installed.

Reinforced Extension Arms

A corrosion-resistant, 1" x 2" top reinforced extension arm and lower 2" x 4" reinforced extension arm attach to the outer perimeter and the base of the backboard frame allowing for the preferred clear view style. 3' extension arms still provide ample room for lay-ups and fast paced game play along with stability and strength.

Galvanized Steel Pole

Constructed from 4" square 7 gauge galvanized steel, the 435 MAX System is built to handle aggressive play. Pole is a manufactured one-piece construction galvanized steel pole with double welded base gussets. Steel pole is finished in an attractive black acrylic powder coat for ultimate protection. Durable 2" thick fitted pole and base pad is included.

Stress-Free Height Adjustment

The goal effortlessly adjusts anywhere from 6' to 10' with the smooth lift-assist, pre-assembled cylinder. The lift-assist ingenuity counterbalances the weight of the backboard so even a small child can raise and lower the goal. The stainless steel handle is removable to prevent unwanted tampering.

Douglas® Pro™ Basketball

(Item # 39750)

Baden official size 29.5" indoor/outdoor basketball. Performance traditional color composite cover with a grip made for indoor/outdoor play. Perfection® symmetrical design for a perfectly balanced ball providing great consistency. The widely-spaced panels ensure you won't get the feel of lumps or inconsistent bounces. Recessed Stealth Soft-Valve System™ for an almost undetectable valve.



Custom Graphics

Pole Pad Wrap

(Item # 29240)

Upgrade your plain black pole pad for a completely custom look! Pole Pad Wraps are made of heavy duty, weather resistant 18.5 oz. solid vinyl and simply fit right over your existing fitted Douglas® D-Pro™ Series pole pad. Perimeters are finished with strong lock stitching and sewn Velcro straps. Digitally printed graphics can be virtually any design or colors.



Replacement Padding



Replacement Padding Set

(Item # 39026)

Replacement form fitted pole and gusset base padding for Douglas Pro™ and F5™ Series. Pad fits 6" square pole. Padding is manufactured with durable black all-weather vinyl that is UV and all weather resistant. Dense foam padding is 2" thick for maximum impact protection. Padding secures in the back with sewn-in overlapping Velcro straps.



Both shown with optional printing

Wraparound Pole Padding

(Item # 29220)

Wraparound pole pad measures 20" wide x 6' high. Pad is secured around pole with double stitched Velcro straps. Two inch thick high impact foam padding is wrapped in black all-weather vinyl. Material is mildew and UV resistant. Pad is universal and fits up to a 6" SQ or 5-9/16" OD round pole.

Fitted Padding

For 4" SQ Pole (Item # 39030)

For 6" SQ Pole (Item # 39050)

Form fitted pad measures 72" high and is designed for either 4" or 6" square poles. High impact foam padding is 2" thick. Black all-weather vinyl is UV resistant with a leather grain appearance. Attaches with sewn in Velcro straps.

Backboard Padding

48" (Item # 39170NG)

60" (Item # 39172NG)

72" (Item # 39173NG)

Sleek design reduces possible ball interference. Black, molded vinyl is designed specifically for outdoor durability. 1 Year limited warranty

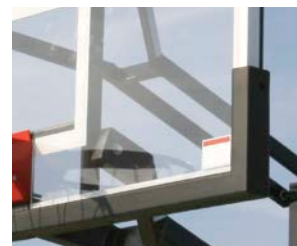

Douglas® F5™ Fixed Basketball Systems

○ Features

The elite Douglas® F5™ Basketball Systems were designed with safety in mind and is the best in its class for ultimate durability and play. The system boasts the high quality features of the adjustable series in a fixed version making it an ideal choice for institutional applications such as neighborhood parks, municipalities, school playgrounds and anywhere else an adjustable system is not desired or needed.

○ 5' Fixed Reinforced Extension Arm

The Douglas® F5™ fixed extension arm overhangs 5' providing stability, strength and extra room for lay-ups and fast competitive play. The unique extension mount is angled and completely out of the play area minimizing any potential contact with the extension mount. The corrosion-resistant 5" x 5" reinforced extension arm attaches to the base of the backboard and to the outer perimeter of the frame allowing for the preferred "clear view" style. Upper brace arms are provided for maximum stability. The Pressure Breakaway Goal attaches directly to the extension arm so it will withstand the weight of even the most aggressive slam dunks.

○ Limited Lifetime Warranty

With over five decades of experience manufacturing elite sports equipment and great customer service to help you identify and solve problems, we stand behind our systems and guarantee a lifetime of dunks. Replacement parts are always readily available, so you never have to miss a minute of playtime.

F/5™ FIXED SERIES



655 MAX

CLEARVIEW
42" x 60" BACKBOARD

POLYCARBONATE (Item # 69562)
GLASS (Item # 69560)



656 MAX

CLEARVIEW
42" x 72" BACKBOARD

POLYCARBONATE (Item # 69574)
GLASS (Item # 69572)

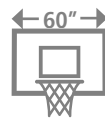

655 STEEL

42" x 60" BACKBOARD

STEEL (Item # 69565)

Recreational Basketball Systems

F/4™ FIXED



- Douglas® F4™ Fixed Basketball System
This institutional-grade basketball system is a smaller version of the F5 fixed series. It has a four-foot extension arm to still offer an adequate safe-play area. The F4 system features a simple, easy-to-install design that is an in-ground direct bury. It's ideal for institutional applications such as neighborhood parks, municipalities, and school playgrounds.
- 4" Square Pole
The F4 pole is constructed from 4" square structural steel with a 3/16" wall thickness. It is 14' in length, allowing for a 4' direct burial installation. The steel pole and extension are finished in an attractive black acrylic powder coat to prevent chipping and provide the ultimate corrosion protection against the elements.
- 4' Fixed Reinforced Extension Arm
The Douglas® F4™ fixed extension arm overhangs 4', providing stability and strength and still allowing room for lay-ups and competitive play. The unique extension mount is angled and completely out of the play area, minimizing any potential contact with the extension mount. The corrosion-resistant 4" x 4" reinforced extension arm attaches to the base of the backboard and the frame's outer perimeter, allowing for the preferred "clear view" style. Upper brace arms are provided for maximum stability. The Pressure Breakaway Goal attaches directly to the extension arm so it will withstand the weight of even the most aggressive slam dunks.
- Limited Lifetime Warranty

Gooseneck Basketball Systems

Poles are formed from heavy wall galvanized steel for superior protection against weather elements. Each post is approximately 13' tall, with 3' to be installed in a 4' x 2' concrete footing to ensure long-lasting post stability. All posts contain a backboard mounting plate welded to post end for hassle-free attachment to most backboards. 5-9/16" are comprised of Schedule 40 steel, providing unmatched strength and durability to the units. Optional custom outdoor weather resistant pole pads are available. Standard in-ground installation.

Pole Options:

- 4-1/2" OD with 4' Extension, 25-Year Limited Warranty (Item # 39180)
- 5-9/16" OD with 6' Extension, Limited Lifetime Warranty (Item # 39180M)

Complete Systems:



4.5 FAL (Item # 69440)
4.5" OD pole, Fan Shaped Aluminum Backboard and Dura Goal I



4.5 FST (Item # 69441)
4.5" OD pole, Fan Shaped Steel Backboard and Dura Goal I



4.5 RST (Item # 69442)
4.5" OD pole, 42" x 60" Steel Backboard and Dura Goal I



4.5 RPGR (Item # 69443)
4.5" OD pole, 42" x 60" Acrylic Backboard and Pressure Flex Goal



5-9/16 RST (Item # 69450)
5-9/16" OD pole, 42" x 60" Steel Backboard and Dura Goal I



5-9/16 RPGR (Item # 69451)
5-9/16" OD pole, 42" x 60" Acrylic Backboard and Pressure Flex Goal

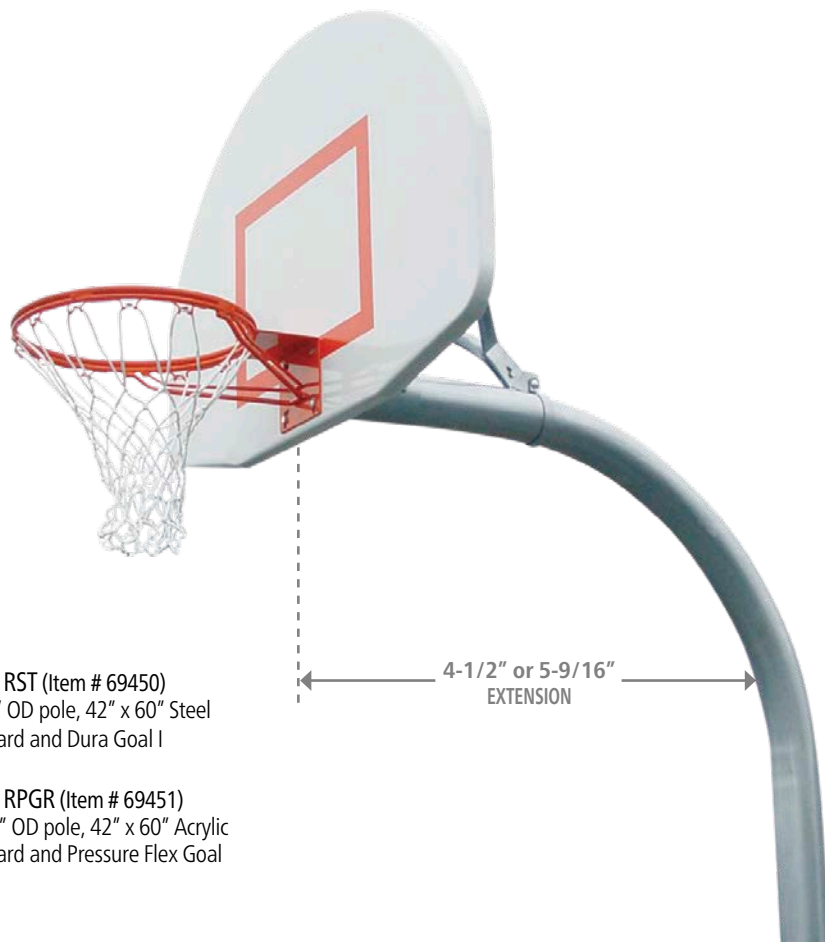

Replacement Backboards & Goals

Backboard Options



FST: Fan Shaped Steel
(Item # 39165)
38" x 55" Fan-Shape Steel backboard has a 12 gauge steel shell with white powder-coat finish and printed target and border. Keyhole slots are positioned at 20" vertically by 35" horizontal centers for mounting. Has reinforced mounting points, including (2) safety mount holes which reduces vibration. Compatible Mounting: Ceiling and Wall Mounted systems, Gooseneck and Straight-Arm Posts. 5" x 4-1/2" Hole Spacing. 10 Year Limited Warranty.



FAL: Fan Shaped Aluminum
(Item # 39166)
36-1/2" x 54" Fan-Shape Aluminum Backboard is constructed of cast aluminum with a white powder coat finish and a printed target and border. Has 20" x 35" mounting centers for attaching board to structure. The backboard features 12 reinforced mounting points to hold the backboard in place. 5" x 4-1/2" Hole Spacing. Limited Lifetime Warranty.



RST: Rectangular Steel
(Item # 39161)
42" x 60" durable Rectangular steel backboard has a 12 gauge steel shell with white powder-coat finish and printed target and border. Has integral reinforcing steel channel on reverse side for mounting and increased board support. Has 20" x 35" mounting centers for attaching board to structure. Capable for direct mounting with integral keyhole slots to permanently attach board to post and allow for goal replacement without removing board. 5 x 5 hole spacing. 10 Year Limited Warranty.



RPGR: Rectangular Clear Acrylic
(Item # 39110A)
42" x 60" Rectangular clear acrylic backboard. 3/8" thick shatter proof clear acrylic is fade resistant and will never fog or cloud. The acrylic is also highly resistant to scuffs and abrasions. Backboard is encased in an all aluminum frame, completely supported by a welded steel back frame. Has a standard 5" x 5" hole pattern. 2 Year limited warranty.

Goal Options

All goals are constructed of durable steel with a CSPC compliant powder-coat finish. Rims have a standard 5 x 5 bolt pattern. Goals are complete with net and hardware and offer an easy no-tie net attachment. A fixed rim is comprised of (4) basic components: ring, bracing, net attachment and back-plate. As you add rings, ring diameter and strengthen bracing – you are building a stronger rim. Fixed rims are not recommended on glass backboards.



Pressure Flex Breakaway Goal
(Item # 39661)
Goal is designed with challenges of outdoor elements in mind and offers durability and performance. Recreational breakaway goal will protect your backboard from the stress of heavy, unsupervised play and repetitive dunks. Features a 5/8" thick, 18" Steel Rim. Goal has an extended wing brace and a single spring flex breakaway mechanism enclosed within a steel cover. Hole spacing is 4-5" x 5". Includes nylon net. 2 Year Limited Warranty.



Dura Goal I
(Item # 39159)
Front mount Dura Goal I offers affordable and yet superior playground performance. 18" Double steel ring has a 5/8" top ring and 1/2" bottom ring. Rim has dual 5/8" x 15" bracing and a universal back plate. Fixed rims are not recommended on glass backboards. Includes nylon net. 2 Year Limited Warranty



Dura Goal II™
(Item # 39157)
Front mount Dura Goal II offers affordable and yet superior playground performance. 18" Double steel ring has a 5/8" top ring and 1/2" bottom ring. Rim has dual 5/8" x 15" bracing and a universal back plate. Includes chain net. 2 Year Limited Warranty



BG-2
(Item # 39158)
This Institutional fixed goal is affordable and yet offers superior playground performance. 5/8" thick, 18" steel rim. Single 5/8" x 15" support bracing. Includes nylon net. 2 year limited warranty

MAX Wall Mount Basketball Systems



W-35 Model
42"W x 60"H (Item # 39147)

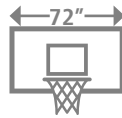

W-36 Model
42"W x 72"H (Item # 39146)

The MAX wall mount adjustable basketball systems can be installed inside or outside. The weather proof system easily adjusts anywhere from 7'6" to 10' to accommodate even the youngest players.

The "clear view" backboards have an aluminum frame and are constructed from 3/8" thick tempered glass. The durable steel breakaway goal will protect your backboard from the stress of aggressive plays. Sleek backboard protective padding is included and pre-installed for your convenience.

The adjustable system has a 3' extension mount from wall to backboard allowing the goal to be adjusted from 7'6" to 10'. The goal's lift assist height adjustment features a height gauge and a stainless steel removable handle to prevent any unwanted tampering. The support frame is constructed from black powder coated steel for ultimate weather protection.

10 Year limited warranty.

Douglas® Indoor Wall Padding



Indoor wall padding is ideal for applications such as school gym walls, basketball court walls, wrestling rooms, daycares, home sport courts and much more! Protective padding adds safety for players and prevents any potential injuries. Custom padding is made to your specifications with a maximum individual panel size of 8' high X 4' length.

Padding is custom fabricated with 2" thick high-impact foam and then wrapped in durable long lasting 14 oz. solid vinyl. The flame resistant vinyl covering meets the strict state of California Fire Marshall requirements. All gym wall pads are backed with 3/4" thick plywood for direct wall attachment by either 1" lip or z-clip installation method.



Standard Colors. Additional Colors available on page 47.

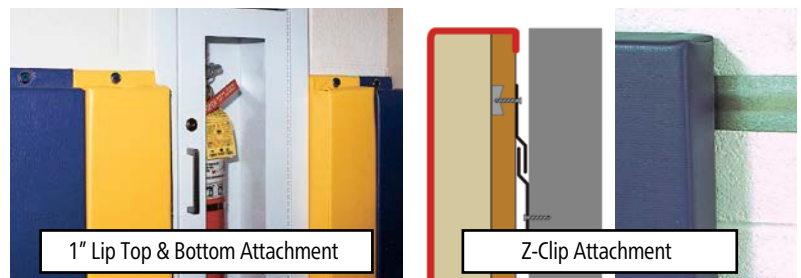

Custom Graphics

Our vinyl fabrics can be digitally printed with our high-quality UV digital printing process. Our elite printing process allows us to print directly on our material. Your investment will not crack peel or tear like vinyl decals. Our digital printing allows for more detailed multi-colored capabilities and has a quick turnaround and greater accuracy.



Douglas® Outdoor/Sand Volleyball



○ Douglas Steel Volleyball Systems

These durable systems are great for parks and recreation installations, sports facilities, or backyard court creation.

Douglas systems are made in the USA and are constructed from square steel for sand or grass ground sleeve installation. These ultra-strong posts have a lifetime guarantee from bending. All steel components are finished with a black, baked-on polyester powder coat finish. This strong finish adds resistance to chipping and the ultimate weather protection against the elements. The net collars are adjustable, allowing for easy height adjustment between 7'4" and 8' official play.

The rugged net tensioning reel case and gears are constructed of heavy-duty steel. This simple reel assembly is easy to use and has smooth operation. The handle has a comfortable contoured grip and is removable to prevent unwanted tampering.

The competition nets meet the USVBA standards, measuring 36" in height and 32' in length. The black netting is 3.0 mm in standard 4" square mesh. The perimeter bands are constructed from 2.5" wide 20 oz. white vinyl. Nets are braced with fiberglass dowels. The top cable is 41" in length and is vinyl-coated steel with a 3600 lb. break strength.

Systems offer a 5-year limited warranty.

VBS-3SQ (Item # 65200)

Durable steel volleyball system is built to withstand outdoor abuse and can be used for either grass or sand courts.

- 3" SQ steel tubing with a 1/8" wall thickness
- Poles are 10'6" in length, allowing 24" for installation
- 36" L X 32' L Volleyball Net, with rope in bottom net band

This solid system is constructed of 3" square steel tubing with a 1/8" wall thickness. Poles are 10'6" in length. System includes the VB-1200RB power volleyball net. This competition net meets USVBA standards and has a 6 mm rope in the bottom net band. Posts can be permanently placed in the ground or installed with optional seamless 24" aluminum ground sleeves for a semi-permanent installation. System can also be installed for sand volleyball with the 36" steel ground sleeves.

24" Aluminum Ground Sleeves (GS-24SQ/AL) (Item # 63172)

36" Steel Ground Sleeves (GS-36SQ) (Item # 63422B)
Includes collars for sand volleyball installation



42" Steel Ground Sleeves (GS-42SQ) (Item # 65275)



VBS-3.5SQ (Item # 65250)

Top of the line steel volleyball system is built for prolonged outdoor use.

- 3-1/2" SQ tubing with a 3/16" wall thickness
- Poles are 12' in length, allowing 42" for installation
- 36" H X 32' L Net with steel cable in bottom net band

This durable system is constructed of 3-1/2" square steel with a 3/16" wall thickness. Poles are 12' in length, allowing 42" for sand or grass ground sleeve installation. System includes the VB-1200 power volleyball net. This competition net meets the USVBA standards and has a 38" steel cable with a 2400-lb. break strength in the bottom net band. Posts can be permanently placed in the ground or installed with optional seamless 42" steel ground sleeves for a semi-permanent sand or grass play installation.



Aluminum Volleyball System (Item # 65350)

This elite outdoor aluminum volleyball system offers the ultimate durability and weather resistance and can be used for either grass or sand courts. This system is great for parks and recreation installations, sports facilities, or backyard court creation.

- 4" SQ extruded structural aluminum
- Poles are 10'6" in length, allowing 24" for installation
- 36" H X 32' L Net with steel cable in bottom net band

This solid system is constructed of 4" square extruded structural aluminum with excellent bend resistance and is 100% rust-proof. The post and steel hardware components are finished with a black, baked-on polyester powder coat finish. This strong finish adds resistance to chipping and the ultimate weather protection against the elements. Poles are 10'6" high, and the complete system is only 150 lbs. Square poles feature a continuous structured channel, so there are no external pressure points to damage the post's finish. The built-in channel allows for easy net height adjustment from 7'4" to 8' official play. The rugged net tensioning reel attaches in the built-in channel. The case and gears are constructed from heavy-duty steel. This smooth operation reel assembly is easy to use and has a removable handle to prevent unwanted tampering. The VB-1200 Competition net meets the USVBA standards, measuring 36" in height and 32' length. The bottom band has a 38" steel cable with a 2400-lb. break strength. Posts can be permanently placed in the ground or installed with optional seamless 24" aluminum ground sleeves for a semi-permanent installation. System can also be installed for sand volleyball with the 36" aluminum ground sleeves.



24" Aluminum Ground Sleeve (GS-24SQ) (Item # 65280)



36" Aluminum Ground Sleeve (GS-36SQ) (Item # 65270) Includes collars for sand volleyball installation



Volleyball Nets

Nets are 32' length and meet USVBA standards. Black netting is 3.0 mm in standard 4" square. Perimeter bands are constructed from 2.5" wide 20 oz. white vinyl. Nets are braced with fiberglass dowels. Top cable is 41' in length and is vinyl coated steel with a 3600 lb break strength. Cable ends are double pressed for strength.

36" High Nets

VB-1200 (Item # 25014)
Bottom band has a 38" steel cable with a 2400-lb. break strength.

VB-1200RB (Item # 25013)
6 mm Rope in bottom net band.

39" High Nets

VB-1500 (Item # 25015)
Bottom band has a 38" steel cable with a 2400-lb. break strength.

VB-1500RB (Item # 25016)
6 mm Rope in bottom net band.



Volleyball Post Padding (Item # 25100)

Wraparound post pads measure 3'8" wide x 6' high. Pad is secured around pole with double stitched Velcro straps. Two inch thick high impact foam padding is wrapped in black all-weather vinyl. Material is mildew and UV resistant. Pads are universal.



Boundary Lines

1" Blue Webbing (Item # 35110)

2" Black Webbing (Item # 35112)

Outdoor boundary lines are perfect for sand or grass play and are adjustable to FIVB standards. Sets include four 10" ABS corner stakes with bungee cord attachments, and durable plastic buckles that allow for proper adjustment to court boundary; is easy to use and designed for long-lasting use. Choose from blue 1" webbing or black 2" webbing.

Douglas® Unicourt™

○ Customize your court with high quality USA manufactured components from Douglas®

Court layouts may be designed for a space as small as 25' x 25' or even smaller by special design. Unicourt™ provides highly competitive sports activities for people of all ages.

Put the Unicourt™ net up and play tennis, pickleball, volleyball or badminton or take the net down and play basketball, no-goalie soccer and floor hockey.



○ Adjustable Net Systems

These systems offer the versatility to easily adjust the net anywhere from ground level to 8' on the pole allowing play for a variety of court sports. Both aluminum and steel systems have a black baked-on polyester powder coat finish. This durable finish adds resistance to chipping and the ultimate weather protection against the elements. Both systems include the Reel-1 net tensioning hardware. This rugged net tensioning reel case and gears are constructed from heavy duty steel. This simple reel assembly is easy-to-use and has a smooth operation. Handle has a comfortable contoured grip and is removable to prevent any unwanted tampering. The net can easily be removed for any open court play. The Unicourt™ multi-purpose net and ground sleeves are sold separately.



Steel Adjustable Net System

3" SQ (Item # 68126S)
3.5" SQ (Item # 68125S)
With the Douglas® Steel Adjustable Net System you simply adjust the collars anywhere from ground level to 8' on the post. Choose from a 3" square steel pole with a 1/8" wall thickness or a 3.5" square steel pole with a 3/16" wall thickness. The multipurpose net system includes all hardware including (8) collars for height adjustments. The steel system can be used with the in-line light system option.

24" Aluminum Ground Sleeve for 3" SQ (SGS-24SQ) (Item # 68126S)

42" Aluminum Ground Sleeve for 3.5" SQ (SGS-42SQ) (Item # 68150AL)



Aluminum Adjustable Net System (Item # 68127S)

With the Douglas® Aluminum Adjustable Net System you simply move the net pulleys and open eye hooks to the desired location within the continuous structured post channel. The built-in structured channel allows for quick and easy net height adjustments. This solid system is constructed of 4" square extruded structural aluminum that has excellent bend resistance and is 100% rust proof. Poles are 10'6" high and the complete system is only 150 lbs.; which is half the weight of a comparable steel system. All post hardware is included. The Unicourt™ net and ground sleeves are sold separately.

24" Aluminum Ground Sleeve (SGS-24SQ) (Item # 68152AL)



○ In-line Adjustable Net Pole System

Aluminum In-Line System (Item # 68253) Steel In-Line System (Item # 68251C)
Ground Sleeve (SGS-24SQ) (Item # 68152AL) Ground Sleeve (SGS-42SQ) (Item # 68150AL)

The In-Line adjustable net system allows court design versatility by allowing the D-Pro™ adjustable basketball systems to be installed on the side of the court and used as part of the adjustable net system. The in-line system includes the wind-up post from the adjustable net system, d-rings and self drilling screws. The Unicourt™ net is sold separately. Choose from 3.5" square steel with 3/16" wall thickness or 4" square aluminum. Adjustable collars (steel) or in-line open eye hooks (aluminum) allow for the net to be adjusted from ground level to 8'. This setup offers the same versatility as the standard adjustable net system.





Unicourt Nets

High quality Unicourt™ nets are made of 1-3/4" square mesh in 3 mm heavy-gauge netting making it unsurpassed for durability and weather resistance. The headband is lock-sewn in a 2 ply vinyl coated polyester. Vinyl bottom tape and side pockets are also polyester based and won't shrink, mildew or rot when exposed to the elements. The net comes complete with side dowels and (4) bungee cords for installation. Nets measure 34" high and are available in (4) standard widths or are custom made to the width of your court. To determine net length, subtract 4' from the distance between the posts.

Light Systems

Extend the available play time of your court by adding the Premium LED light system. The LED Systems feature (2) 100 Watt LED Floodlights with 13,500 delivered lumens per light fixture and 5000K light color ensures a bright clear light. High strength aluminum housing make this an industrial grade quality and is built to last. Unit is waterproof for all weather conditions. Backed by a 5-year warranty. Choose from an in-line or standalone light system. Both installation options are finished with black polyester powder coat for maximum weather resistance.



Standalone Light System

Standalone Pole System (Item # 68517)

Ground Sleeve (SGS-425Q) (Item # 68150AL)

The standalone pole is constructed from 3.5" square steel and top pole is 3" square steel. The installed light height is approximately 17' above ground.

In-Line System (Add-On) (Item # 68513)

This "In-Line" system is to be used as an extension to the steel adjustable net system. The extension system includes a 3" square x 10'6" steel light pole with collar, extension arm and light fixtures with lamps and fits into the top of a steel 3.5" square x 12' adjustable net system pole.



Rebounders

10'H x 10'W (Item # 68304B) 10'H x 20'W (Item # 68300B)

Add a standalone rebounder to your court or incorporate the rebounder into the custom fence system. The rebounder frame is constructed of 1.9" 16-gauge black powder-coated steel and measures 10' high x 10' or 20' wide. The net is sewn from black heavy-duty #420 pylon, 7/8" mesh netting. This knotless netting has a 125 lb. break strength and is weather treated to withstand moisture and sunlight. Netting is reinforced with a double sewn 1-1/2" wide vinyl tape border. Brass grommets are evenly spaced for securing the net to the frame with the provided bungee cords. A white webbing strap to set a realistic tennis net height and vinyl bottom ball retainer is included. Complete unit includes fittings, adjustable straps, black bungee cords, vinyl ball retainer, rebounder net and PVC ground sleeves.



D-Pro™ MAX Adjustable Basketball Systems

Choose from (3) standard units to meet your needs. Features include completely welded components for uncompromising strength and durability, and a superior mounting system for ease of installation and relocation. The D-Pro™ series comes complete with a tempered glass backboard, Pressure Flex™ Goal, backboard padding, and pole padding.

See page 26 for more specifications and pictures.

Combination Basketball - Suggested Layout 1

- Fence System with Rebounder option
- D-Pro™ MAX Adjustable Basketball
- In-Line Adjustable Net System
- Extension Light System
- Unicourt™ Net

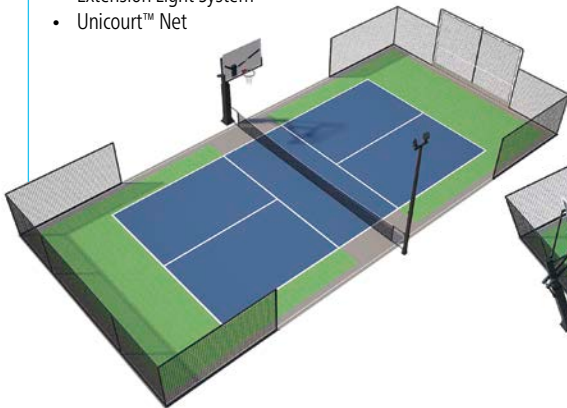

Single Basketball - Suggested Layout 2

- Fence System with Rebounder option
- Adjustable Net System
- D-Pro™ MAX Adjustable Basketball
- Extension Light System
- Unicourt™ Net

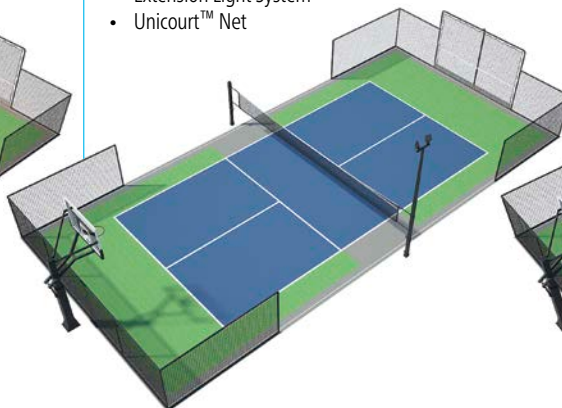

Dual Basketball - Suggested Layout 3

- Ball Containment Fence System
- Adjustable Net System
- (2) Pro™ MAX Adjustable Basketball
- Extension Light System
- Unicourt™ Net

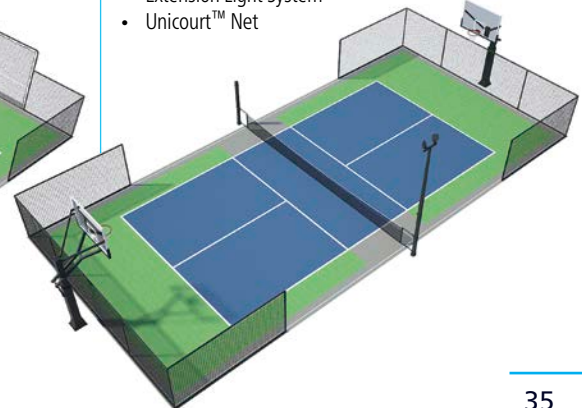

Soccer

Pro Soccer Goals, 4" Round

Official size: 8'H x 24'W x 3'D x 9'B (Item # 37800)

These classic soccer goals are built to withstand the rigors of high-level high school or collegiate play. Official-size goals measure 8'H x 24'W x 3'D x 9'B and meet NFSHSA, NCAA and FIFA specifications for regulation soccer play.

Strong, Front face frame is constructed of 4" tubular aluminum with a white powder coat finish. Back stays are 2" round powder coated aluminum and rear crossbars are made from 2" galvanized steel for exceptional support and balance. Frame has a built-in net clip track for easy net installation. Includes durable 4 mm white nets and net clips to secure to track. Ground anchors are included to lock down the netting. Sold per pair.



Round Design Showing Net Clip Track



Ground Anchor Attachment



Optional Wheel Kit for easy mobility



Club Portable Soccer Goals, 3" Round Aluminum

8'H x 24'W x 3'D x 8.5'B (Item #37810)

7'H x 21'W x 3'D x 7.5'B (Item #37811)

6.5'H x 18.5'W x 2'D x 7'B (Item #37812)

6.5'H x 12'W x 2'D x 7'B (Item #37813)

4.5'H x 9'W x 2'D x 4.5'B (Item #37814)

4'H x 6'W x 2'D x 4'B (Item #37815)

Durable aluminum construction withstands rough weather and the repeated impact of shots on goal. 8' x 24' model meets NFSHSA specifications. Front face is made from 3" round custom aluminum extrusion with a durable white powder coated finish. Back stays are constructed of 2" round heavy wall aluminum tubing. Frame has double-reinforced, TIG-welded corners and stainless-steel hardware. The included 4 mm white nets install easily with the frame's built-in net clip track and net clips. Ground anchors keep the goals in place during windy conditions and powerful kicks. Goal is available in a variety of sizes to accommodate players of all skill levels. Back bottom bar is included with 24', 21' and 18.5' wide models. Sold per pair. Systems include net clips and ground anchors.



Round Design Showing Net Clip Track



Net clip track in front face frame



Net Clip Track in Top and Side Frames



Heavy-wall backstays

Foldable/Portable Indoor Goal

Complete Goal (Item # 37430)

Replacement Net (Item # 37431)

Portable indoor Soccer Goal is ideal for practices, tournaments or recreational play. Frame measures 6.5' high x 12' wide and 5' deep. The goal goes up quickly and is easy to reposition and transport. Back stays fold inward and encourages compact storage and portability for indoor soccer. Face frame is 2" square, white powder-coated steel that can withstand a barrage of hits. Soccer net is made up of durable 3 mm white polyethylene netting. Non-marking floor pads on all four contact points of the frame ensure gym floors stay unmarked. Sold as a single goal with net.



○ Soccer Nets

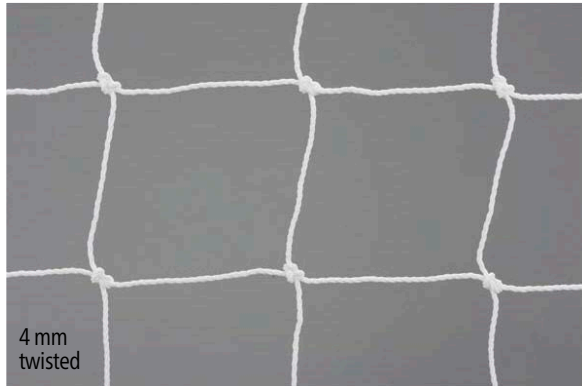
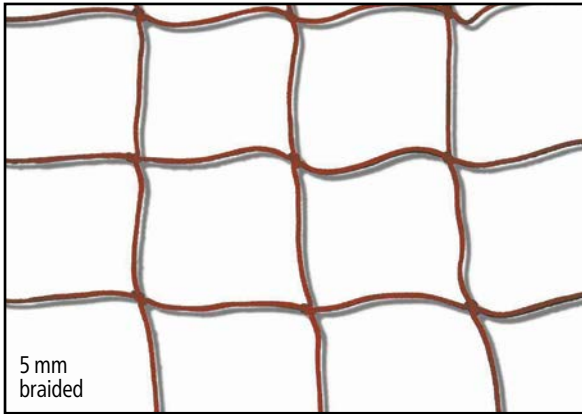

Durable, replacement polyethylene soccer goal nets. Nets are available in 5 mm braided polyethylene or 4 mm twisted knotted polyethylene. 5 mm braided nets are available in either white or orange.

Item #	Size				Material	Color
	Height	Width	Top Depth	Bottom Depth		
37080	8'	24'	5'	10'	5 mm braided polyethylene	White
37081	8'	24'	5'	10'	5 mm braided polyethylene	Orange
37082	8'	24'	3'	8.5'	4 mm twisted knotted PE	White
37083	7'	21'	3'	7.5'	4 mm twisted knotted PE	White
37084	6.5'	18.5'	2'	7'	4 mm twisted knotted PE	White
37085	6.5'	12'	2'	7'	4 mm twisted knotted PE	White
37086	4.5'	9'	2'	4'	4 mm twisted knotted PE	White
37087	4'	6'	2'	4'	4 mm twisted knotted PE	White

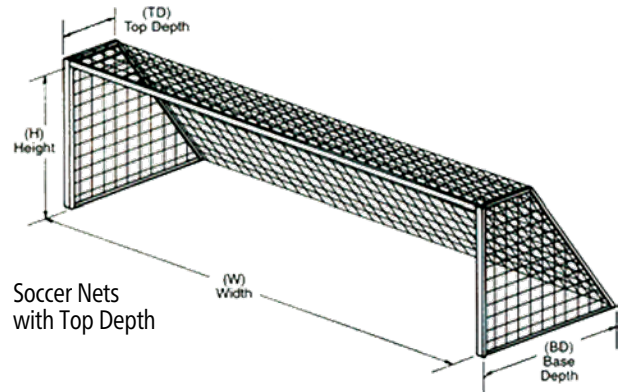

○ Soccer Accessories



Wheel Kit for Portable Soccer Goals (Item # 37835)

Easily move your portable soccer goals with this add-on wheel kit. Attaches to any back stay up to 2" OD. Kits are sold in sets of (2) wheels. Two sets are required for a pair of goals.



Velcro Soccer Net Straps (Item # 37839)

Hook and loop soccer net straps keep netting in place. Constructed with hook-and-loop closures, the straps adjust to wrap around different-size poles, and they easily pull apart when it's time to change the netting or take the soccer goals down at the end of the season. With a set of 24 straps, teams can secure all angles of the net on each end. Hook-and-loop design is easily adjustable to fit different poles. White design coordinates easily with any color goal and doesn't stand out. Sold in sets of 24 pieces.



Twist-in Net Hooks (Item # 37838)

White plastic net hooks twist-in and secure net to soccer goals. Sold in a set of (50) quantity.



In-Ground Anchors (Item # 37836)

12" long; 2" OD galvanized steel. (4) anchors per goal required.



○ Douglas' Complete Netting Systems (Item # 67200)

Complete your facility with Douglas' permanent netting systems that are designed to stop balls, prevent property damage and provide player and spectator safety. All systems include high-quality netting, poles, and all the hardware needed for a complete installation. These netting systems are ideal for multi-sport facilities where multiple games or practices are going on simultaneously. Systems are designed to meet your specific needs and can be custom fabricated to virtually any size.

Permanent Netting Systems come with everything you need including heavy-duty steel poles, netting, high-tension cable and hardware. Permanent systems are great for baseball/softball protective netting as well as barrier netting for multi-sport facilities. Any height can be accommodated up to 40' and custom sizes are available.

Quality outdoor netting is UV and weather resistant and is custom made for your project and application. Choose from various netting mesh sizes including 1-3/4" SQ Mesh, 1-1/2" SQ Mesh, 4" SQ Mesh and also 7/8" SQ Mesh.

Douglas® Ballpark Netting

1-3/4"
Mesh

○ #12 Knotted UHMPE Dyneema

Major league professional backstop netting provides maximum protection with maximum viewing. This strong netting is only 1.4 mm with a 94% visibility rate. Twisted knotted Dyneema is an ultra high molecular weight polyethylene (UHMPE). Material is treated for maximum UV and weather resistance. Netting perimeter is finished with a 1/4" solid braid sewn rope border. Rope border has 1,500 lb break strength.

1-3/4" SQ Mesh

Medium weight, 308 lb. break strength; 94% visibility
(Item # 26012)

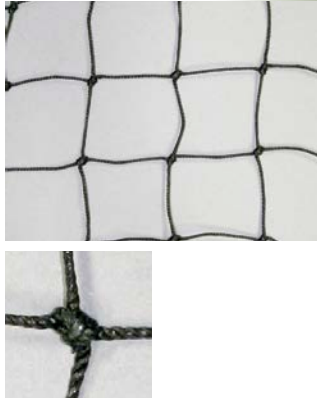

○ #42 Knotted Ultra HDPE

Premium Twisted Knotted Ultra High Density Polyethylene is made with specialized treatment to provide the strength of nylon with the UV and weather resistance of polyethylene. This high impact backstop netting is 2.4 mm thick with a break strength of 392 lbs. Netting perimeter is finished with a 1/4" solid braid sewn rope border. Rope border has 1,500 lb. break strength.

1-3/4" SQ Mesh

High Strength, 392 lb. break strength
(#26142)



○ Twisted Knotted Nylon

This high tensile strength black nylon netting is ideal for medium to high impact backstop and protective screen applications. Outdoor netting has been treated for UV and weather resistance. Netting is finished with a rope border which allows for a simple and easy installation.

1-3/4" SQ Mesh with Rope Border

LIGHT WEIGHT

#18 Black 194 lb. break strength (Item # 36098A)

#21 Black 237 lb. break strength (Item # 36099A)

MEDIUM WEIGHT

#36 Black 345 lb. break strength (Item # 36099B)

HEAVY WEIGHT

#42 Black 435 lb. break strength (Item # 36099C)

#48 Black 472 lb. break strength (Item # 36099D)

#60 Black 720 lb. break strength (Item # 36099E)

#72 Black 862 lb. break strength (Item # 36099G)

#96 Black 1,112 lb. break strength (Item # 36099F)



○ Knotless Polypropylene HTPP

This premium high tenacity Polypropylene (Pylon) netting offers the most longevity and durability. Pylon netting is a great all-purpose netting with an attractive appearance and good strength. Outdoor netting is treated and extruded through the fibers for maximum weather and UV resistance. Netting can be finished with a rope or vinyl border. A rope border offers a simple and easy installation. The vinyl edging provides the netting with added strength while keeping the nets shape. The reinforced, double stitched vinyl also gives the net a sharp appearance. Optional brass grommets can be added and are placed every 18".

3.0 mm; 1-3/4" SQ Mesh

Medium Weight, 250 lb. break strength

Black, Sewn Rope Border (Item # 22260R)

Black, Tape Bound with Grommets (Item # 22260)

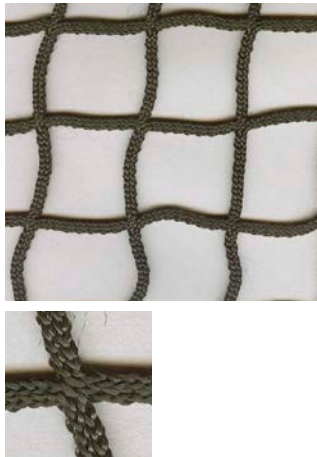

○ Douglas® Backstop Systems

The Douglas® Backstop Netting Systems are available with or without poles and provide a complete professional looking backstop setup. Take the guess work out of setting up your own backstop system and get a complete kit with all of the cable, hardware and custom netting that you need for your unique facility. Choose from the Standard Cable System (Pole-to-Pole) or the Suspended Cable System (Tie-Back) which provides more of a unobstructed view. See page 21 for more information on these systems.

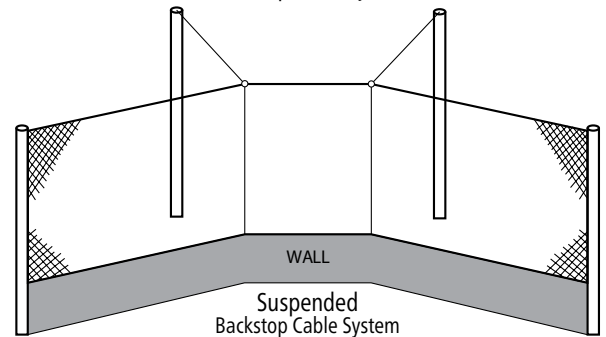
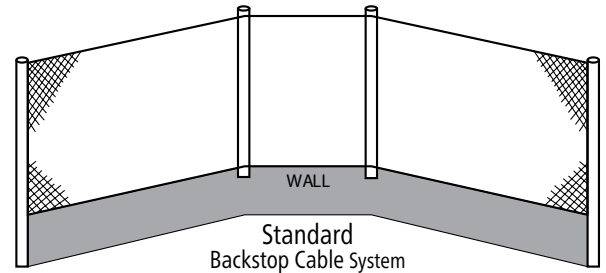



7/8" Mesh

1" Mesh

Golf

- **#18 Twisted Knotted Nylon**
This high tensile strength black nylon netting is ideal for medium to high impact backstop and protective screen applications. Outdoor netting has been treated for UV and weather resistance. Netting is finished with a rope border which allows for a simple and easy installation. #18, Twisted knotted nylon is 1" square mesh with a 194# break strength.
1" SQ Mesh
Medium Weight; 194 lb break strength
Black, with Rope Border (Item # 36098)



- **#18 Twisted Knotted Polyethylene**
This lightweight, polyethylene netting is great for divider netting and low impact barrier protection. Outdoor netting has been treated for UV and weather resistance. Netting is finished with a rope border which allows for a simple and easy installation. #18, Twisted knotted Polyethylene is 1" square mesh with a 105# break strength.
1" SQ Mesh
Lightweight; 105 lb break strength
Black, with Rope Border (Item # 36098PE)

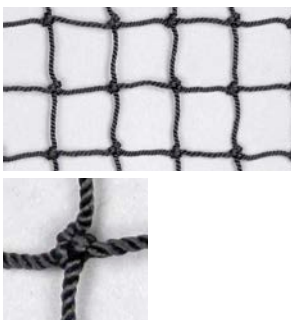

- **#24 Twisted Knotted Nylon**
This high tensile strength black nylon netting is ideal for high impact backstop and protective screen applications. Outdoor netting has been treated for UV and weather resistance. Netting is finished with a rope border which allows for a simple and easy installation. #24, Twisted Knotted Nylon is 3/4" square mesh with a 270# break strength.
3/4" SQ Mesh
Heavy Weight; 270 lb break strength
Black, with Rope Border (Item # 36098B)

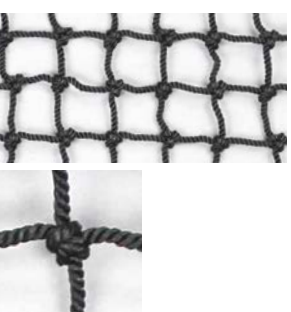

- **#420 Knotless Pylon**
This lightweight, pylon netting is great for divider netting and low impact barrier protection. #420 Knotless Polypropylene (Pylon) is 7/8" square mesh and has a 125# break strength. Choose from Black or White. Black and green styles are weather treated to withstand moisture and sunlight. Natural white netting is for indoor use only. Netting can be finished with a rope or vinyl border. A rope border offers a simple and easy installation. The Vinyl edging provides the netting with added strength while keeping the nets shape. The reinforced, double stitched vinyl also gives the net a sharp appearance. Optional brass grommets can be added and placed every 18".
7/8" SQ Mesh
Light Weight; 125# break strength
Black, Tape Bound with Grommets (Item # 26018)
Black, with Sewn Rope Border (Item # 26018R)
White, Tape Bound with Grommets (Item # 26018W)

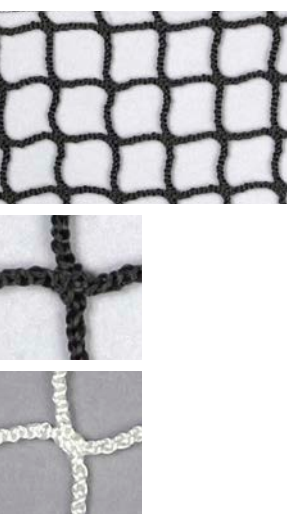

4" Mesh Soccer/Football

- **Twisted Knotted Nylon**
This high tensile strength black nylon netting is ideal for medium to high impact backstop and protective screen applications. Outdoor netting has been treated for UV and weather resistance. Netting is finished with a rope border which allows for a simple and easy installation. #36 Twisted knotted nylon is 4" square mesh with a 352# break strength.



#36 Knotted; 4" SQ Mesh
(Heavy Weight; 352 lb break strength)
Black, with Rope Border
(Item #36099)



- **Premium Knotless Polypropylene HTPP**
This premium high tenacity Polypropylene (Pylon) netting offers the most longevity and durability. Pylon netting is ideal for high impact applications. 4" square mesh, Black 3.0 mm has a 250# break strength and is also available with a flame retardant. Netting is treated and extruded through the fibers for maximum weather and UV resistance. Netting is finished with vinyl edging which provides the netting with added strength while keeping the nets shape. The reinforced, double stitched vinyl provides a sharp appearance. Optional brass grommets can be added and are placed every 18".



3.0 mm; Knotless 4" SQ Mesh
Medium Weight; 250 lb break strength
Black, Tape Bound with Grommets (Item # 25803B)
Black with Sewn Rope Border (Item # 25803BR)



Douglas® Divider Netting

1-1/2"
Mesh

1-3/4"
Mesh

Create a barrier in between tennis courts for uninterrupted play with Douglas® high quality divider nets. Court divider nets are made from knotless pylon and custom fabricated to your facility's required dimensions. We provide both indoor and outdoor court divider netting. Black and green styles are weather treated to withstand moisture and sunlight. Natural white netting is for indoor use only. Kickplates are available for indoor application in either 12" high Solid Vinyl or 18" high VCP. Tape borders are double sewn with 1-1/2" reinforced solid vinyl. Heavy-duty brass grommets are spaced 18" along top (standard) Additional grommets may be specified. Standard heights are 10' or 12' and custom heights are available.



○ #420 Knotless Pylon

This lightweight, pylon netting is ideal for divider netting. #420 Knotless Polypropylene (Pylon) is 1-1/2" square mesh and has a 125# break strength. Choose from Black or White. Weather treated to withstand moisture and sunlight. Netting is finished with a vinyl border and provides the netting with added strength while keeping the nets shape. The reinforced, double stitched vinyl also gives the net a sharp appearance. Optional brass grommets can be added and are placed every 18".

1-1/2" SQ Mesh

Lightweight, 125 lb. break strength

Black, Tape Bound with Grommets (Item # 29102B)
White, Tape Bound with Grommets (Item # 29102W)



○ Premium Knotless Polypropylene HTPP

This Premium high tenacity Polypropylene (Pylon) netting offers maximum longevity and durability. Pylon netting is ideal for high impact applications. 3.0 mm has a 250# break strength and is available in Black, Dark Green or White. Netting is treated and extruded through the fibers for maximum weather and UV resistance. Netting is finished with a vinyl border and provides the netting with added strength while keeping the nets shape. The reinforced, double stitched vinyl also gives the net a sharp appearance. Optional brass grommets can be added and are placed every 18".

3.0 mm; 1-3/4" SQ Mesh

Medium Weight, 250 lb break strength

Black, Tape Bound with Grommets (Item # 22260)
White, Tape Bound with Grommets (Item # 22262)



○ #18 Knotted HDPE Prefabricated Divider Panels

These prefabricated divider netting panels can be used indoors or outdoors. This high density Polyethylene (HDPE) netting offers maximum longevity and durability. Panels are constructed of black #18 knotted 1-3/4" sq. mesh netting with a 125 lb break strength. This HDPE netting is ideal for low impact applications. Netting is treated and extruded through the fibers for maximum weather and UV resistance.



○ Rope Border 10' x 60' Panels

Outside perimeter has a reinforced sewn rope border making it flexible and easy to hang.

1-3/4" SQ Mesh

Lightweight, 125 lb break strength

10' x 60' (Item # 32014)



○ Vinyl Border 10' x 65' Panels

Reinforced vinyl border provides a defined frame for the netting. Vinyl border is double stitched with brass grommets spaced every 18".

1-3/4" SQ Mesh

Lightweight, 125 lb break strength

10' x 65' (Item # 32020)



○ Replacement Kickplates



VCP Mesh Kickplate
18" High with Velcro Top



Solid Vinyl Kickplate
12" High with Velcro Top



Netting Kickplate
24" High with Velcro Top

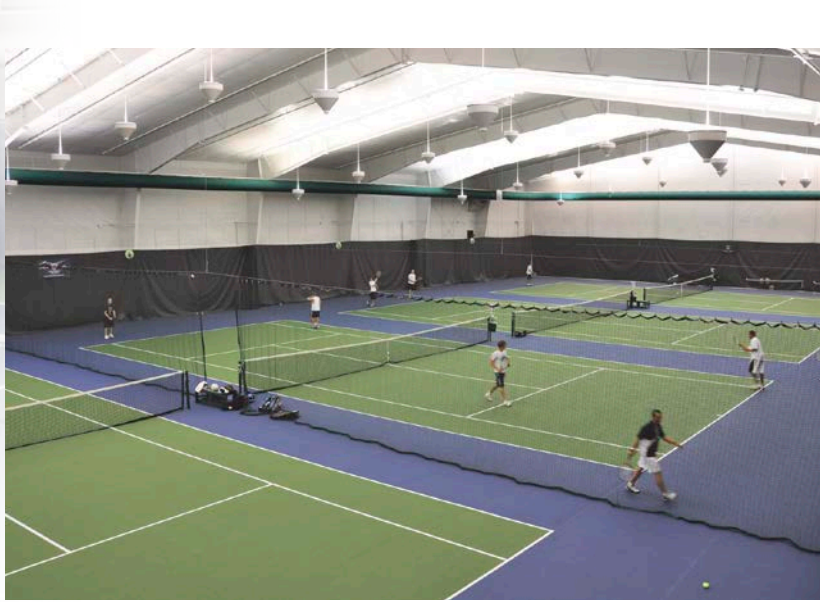

- Vinyl Court Signs
Constructed of 18 oz. vinyl, perimeter is hemmed with grommets.
- Court Numbers (Item # 22204)
Numbers are from 1 through 20 and measure 9" H. Signs measure 12" x 12"
- Exit Sign (Item # 22202)
Red vinyl with white letters measuring 9" high. Sign measures 18"H x 36"L



Douglas® Hockey Netting

1-1/2"
Mesh

1-3/4"
Mesh

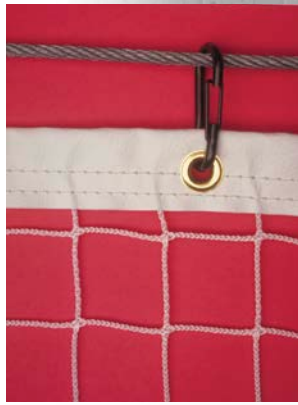

○ Hockey Goal Nets

NHL Professional, 6 mm Resin Coated (HN-600R) (Item # 39234)

High quality knotless woven polyester netting in 2-1/2" stretch diamond mesh. Nets fit professional style goal frames, 6' wide x 4' high with a 44" depth. Complete with lacing cord to secure net to frame.

○ #420 Knotless Pylon

This lightweight, pylon netting is great for divider netting and low impact barrier protection. #420 Knotless Polypropylene (Pylon) is 1-1/2" square mesh and has a 125# break strength. Choose from Black or White. Black is weather treated to withstand moisture and sunlight. Natural white netting is for indoor use only. Netting can be finished with a rope or vinyl border. A rope border offers a simple and easy installation. The Vinyl edging provides the netting with added strength while keeping the nets shape. The reinforced, double stitched vinyl also gives the net a sharp appearance. Optional brass grommets can be added and are placed every 18".

2.0 mm; 1-1/2" SQ Mesh

Lightweight; 125 lb. break strength

Black, Tape Bound with Grommets (Item # 29102B)

Black, Rope Border (Item # 29102BR)

White, Tape Bound with Grommets (Item # 29102W)

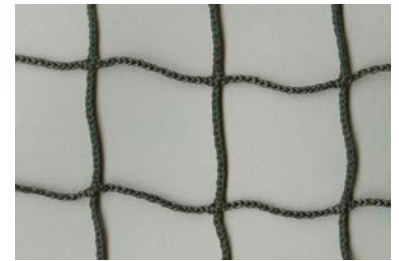

○ Clear Monofilament Netting

1-3/4" clear monofilament square mesh netting. Thickness is 1.10 mm gauge with a 90 lbs break strength. Netting is reinforced with a 5/16" twisted polyethylene rope border.

1.10 mm; 1-3/4" SQ Mesh

Lightweight; 90 lb. break strength

Clear, Rope Border (Item # 39300)



○ Twisted Knotted Nylon

This high tensile strength black nylon netting is ideal for medium to high impact protective applications. Netting has been treated for UV and weather resistance. Netting is finished with a rope border which allows for a simple and easy installation. #30 Twisted knotted nylon is 1-1/2" square mesh with a 320# break strength.

#30; 1-1/2" SQ Mesh

Medium Weight, 320 lb. break strength

Black, Rope Border (Item # 36099H)



ITEM #	MESH SIZE	WEIGHT	COLOR	BREAK STRENGTH	FINISH OPTION	RECOMMENDED APPLICATIONS
--------	-----------	--------	-------	----------------	---------------	--------------------------

#12 Knotted UHMPE Dyneema

Major league professional backstop netting provides maximum protection with maximum viewing. This strong netting is only 1.4 mm with a 94% visibility rate.

26012	1-3/4"	1.4 mm	Black	1,500#	Sewn Rope	High Impact Backstop Netting
-------	--------	--------	-------	--------	-----------	------------------------------



#12 Dyneema

#42 Knotted Ultra HDPE

Premium Twisted Knotted Ultra High Density Polyethylene is made with specialized treatment to provide the strength of nylon with the UV and weather resistance of polyethylene.

26142	1-3/4"	2.4 mm	Black	392#	Sewn Rope	High Impact Backstop Netting
-------	--------	--------	-------	------	-----------	------------------------------



#42 Ultra HDPE

Premium Knotless Polypropylene (Pylon) High Tenacity HTPP

This Premium high tenacity Polypropylene (Pylon) netting offers maximum longevity and durability.

22260 (R)	1-3/4"	3.0 mm	Black	250#	Rope or Tape	Medium Strength All-Purpose Netting,
22262	1-3/4"	3.0 mm	White	250#	Tape	Indoor only
25803B(R)	4"	3.0 mm	Black	250#	Rope or Tape	Soccer, Football, and Volleyball Barrier Netting



3.0 mm Knotless



3.0 mm Knotless

#420 Knotless Pylon

This lightweight, pylon netting is great for divider netting and low impact barrier protection.

26018 (R)	7/8"	2.0 mm	Black	125#	Tape or Sewn Rope	Golf Barrier Netting
26018W	7/8"	2.0 mm	White	125#	Tape	Indoor Golf Barrier Netting
29102B(R)	1-1/2"	2.0 mm	Black	125#	Tape or Sewn Rope	Divider Netting/Hockey Barrier
29102W(R)	1-1/2"	2.0 mm	White	125#	Tape	Indoor only. Divider Netting/Hockey Barrier



#420



#420

#18 Twisted Knotted Polyethylene

This lightweight, polyethylene netting is great for divider netting and low impact barrier protection.

36098PE	1"	#18	Black	105#	Rope	Lightweight Barrier Netting
---------	----	-----	-------	------	------	-----------------------------



#18

Twisted Knotted Nylon

High tensile strength black nylon netting is available in a variety of strengths and mesh sizes.

36098A	1-3/4"	#18	Black	194#	Rope	Lightweight Barrier Netting
36098	1"	#18	Black	194#	Rope	Golf Barrier Netting
36098B	3/4"	#24	Black	270#	Rope	High Impact Netting
36099H	1-1/2"	#30	Black	270#	Rope	Hockey/Lacrosse Netting
36099A	1-3/4"	#21	Black	237#	Rope	Lightweight Barrier Netting
36099B	1-3/4"	#36	Black	345#	Rope	Medium Weight Barrier Netting
36099C	1-3/4"	#42	Black	435#	Rope	High Impact Backstop Netting
36099D	1-3/4"	#48	Black	472#	Rope	High Impact Netting
36099E	1-3/4"	#60	Black	720#	Rope	High Impact Netting
36099G	1-3/4"	#72	Black	862#	Rope	High Impact Netting
36099F	1-3/4"	#96	Black	1,112#	Rope	High Impact Netting
36099	4"	#36	Black	352#	Rope	Soccer, Football, and Volleyball Barrier Netting



#18



#21

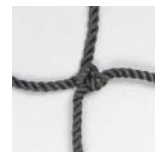

#36



#42

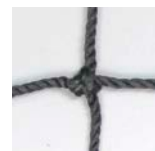

#48



#60

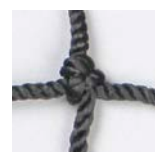

#96

Douglas® Backdrop Curtains / Gym Dividers

Add or replace your existing Gymnasium Divider Curtains with Douglas® quality. Divider curtains allow you to make the most effective use out of your facility by dividing a large open space into smaller sections for various sports and other events. Divider curtains provide safety, visual privacy and a sound barrier between spaces. Curtains can be custom fabricated with all solid vinyl, partial vinyl/partial netting or mesh. Solid vinyl backdrop curtains can also be installed around the perimeter walls of your facility to provide a visual backdrop for players and aesthetic appeal to onlookers.

All curtains are customized to your specifications and produced from the most durable materials available. Choose from heavy duty 14 oz. or 18 oz. vinyl in a variety of colors. Options for the top portion of divider panels are constructed of FR open weave white vinyl mesh or netting. Besteel 170 Series Walk-draw track systems are available for hanging the curtains. Tracks are constructed of 14 gauge galvanized steel in both suspended and direct mount installation options.



14 OZ.. FR VINYL



18 OZ.. FR VINYL

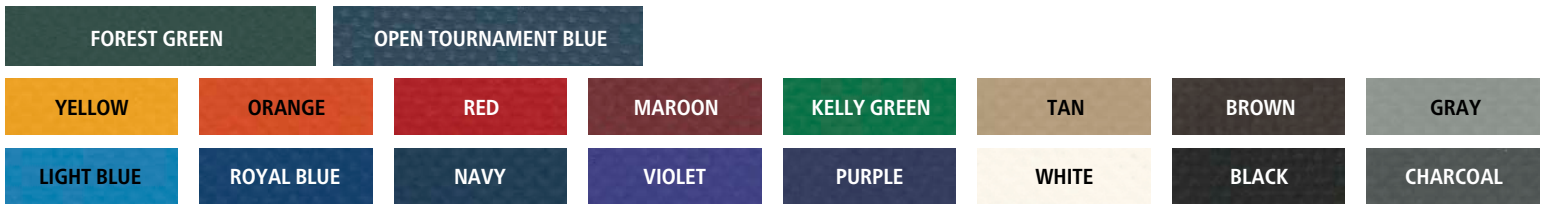

Material

Add or replace your existing backdrop curtains with Douglas® quality. Backdrop curtains are constructed of vinyl coated polyester that is mildew resistant and UV treated. Vinyl material meets California Fire Marshal requirements for flame resistance in indoor use. This strict code meets or exceeds most city requirements. Choose from 14 oz. or 18 oz./square yard weights in a variety of colors. 18 oz. is recommended for greater durability and life expectancy.

Dimensions

Heights of curtains generally range from 9' to 12' and custom heights are available to meet your needs. The maximum recommended length per curtain is 60'.

Fabrication

Seams are heat-sealed and reinforced hems are double sewn with lock stitching. Brass grommets are typically spaced every 12" on the top of backdrop curtains. The sides can be sewn with grommets or Velcro to attach curtains together or without grommets to overlap curtains instead. Douglas can accommodate any special requirements such as placement of doorways, ventilation/viewing cut-outs with netting or mesh screen and divider wings.

Custom Printing

Our vinyl fabrics are digitally printed with our high-quality UV digital printing process. Our elite printing process allows us to print directly on our material so there's no white back side like other digital printing companies. Your printing and logos become part of the material. Your investment will not crack, peel or tear like vinyl decals. Our digital printing allows for more detailed multi-color capabilities and has a quick turnaround and greater accuracy.

Available Colors

Additional colors are available upon request.

*10 oz. White FR Vinyl is also available for High-Line Backdrop Curtains (to go above perimeter backdrop curtains)

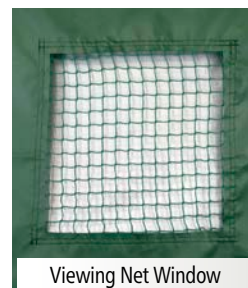
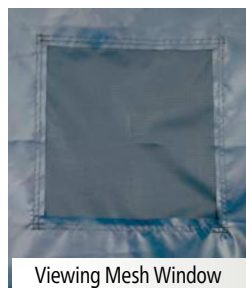

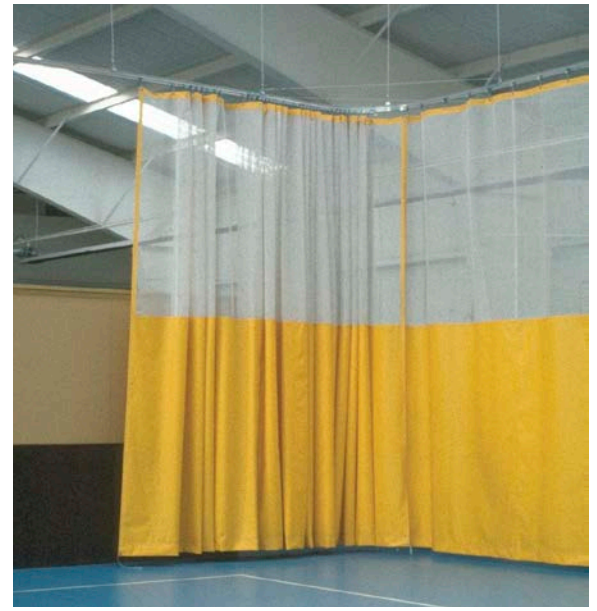

Accessories

Vinyl Court Signs

Constructed of 18 oz. vinyl, perimeter is hemmed with grommets.

Court Numbers (Item # 22204)
Numbers are from 1 through 20 and measure 9" H. Signs measure 12" x 12"

Exit Sign (Item # 22202)
Red vinyl with white letters measuring 9" high. Sign measures 18"H x 36"L



Installation Accessories

Besteel 170 Series Walk-draw Track Systems (Item # 39500)

Available for hanging curtains, these tracks are constructed of 14 gauge galvanized steel in both suspended and direct mount installation options.



- 1/4" Cable, Galvanized (Item # 34728)
- 1/8" Cable, Galvanized (Item # 15102)
- 1/4" Cable Clamp (Item # 34725)
- 1/8" Cable Clamp (Item # 34726)
- 12" Turnbuckle (TB-12) (Item # 34724)
- 6" Turnbuckle (TB-6) (Item # 36986)
- C-Snap, Black Plated Steel (Item # 32670)
- C-Snap, Black Plastic (Item # 32675)
- 8 mm Spring Link (Carabiner) (Item # 36000)

- 5 mm Spring Link (Carabiner) (Item # 32679)
- 3" S-Hook, Steel (Item # 31663)
- TR-50 7" Tie-raps (100/pkg) (Item # 31656)
- TR-120 8" Tie-raps (100/pkg) (Item # 31657)
- TR-50XL 14.5" Tie-raps (100/pkg) (Item # 31651)
- TR-120XL 14" Tie-raps (100/pkg) (Item # 31655)
- 3/16" Polypro Braided Rope (1000' Roll) (Item # 31601M)
- Pulley w/ Split Bracket (Item #34721)

Douglas® Custom Indoor Padding

- Protect players with durable, Douglas® protective indoor wall padding and give your facility a professional look without compromising style.

Standard size indoor padding panels are 2' wide, 6' high and are 2" thick. Padding panels can be custom made per order with the maximum panel size being 4' wide by 8' high. Custom electrical and other cutouts can be met for a precise fit.

Indoor padding is custom fabricated with 2" thick high-impact polyethylene foam and then wrapped in durable long lasting 14 oz. solid vinyl. The flame resistant vinyl is antibacterial, anti-fungal, rot and mildew resistant, and Fire Retardant to meet all standard fire codes including NFPA 701 and California Fire Marshall. All gym wall pads are backed with 3/4" thick plywood for direct wall attachment by either 1" lip installation or z-clip method.

Standard wall pads are available in forest green, black, royal blue, navy blue and red. Additional colors are available upon request.

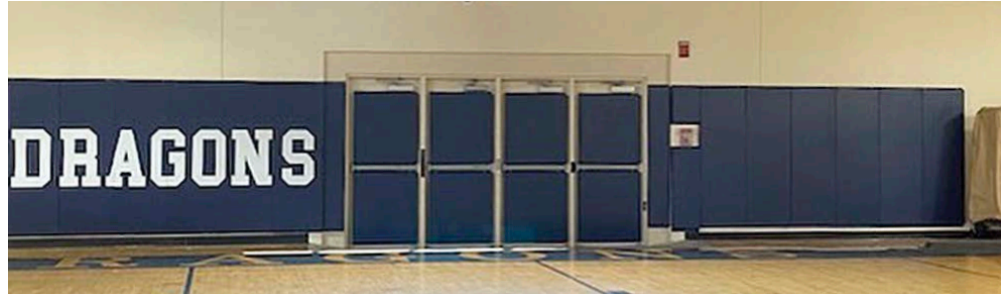

○ Installation Methods

1" Lip Top and Bottom Attachment

The 1" lip top and bottom style has the wood backer extend 1" above and below the foam. With this method, the gymnasium wall pads are bolted directly to the wall through the 1" wood lip. Bolt hardware is not included.



Z-Clip Attachment The z-clip attachment style offers a clean finished look by utilizing a hidden aluminum channel on the back side of the gym wall padding. The z-clip channel is pre installed on the wall pads and the channel track for the gym wall is provided. Bolt hardware is not included.

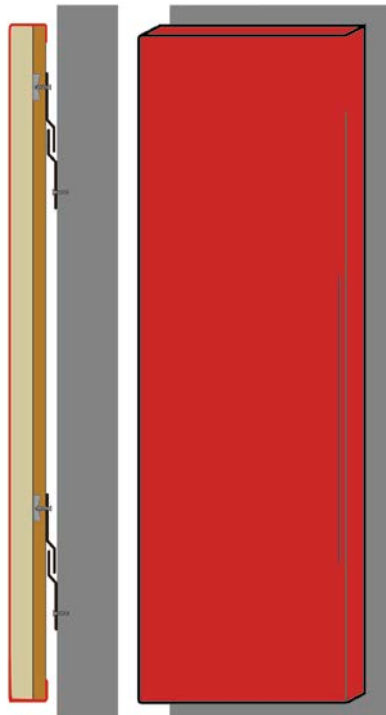
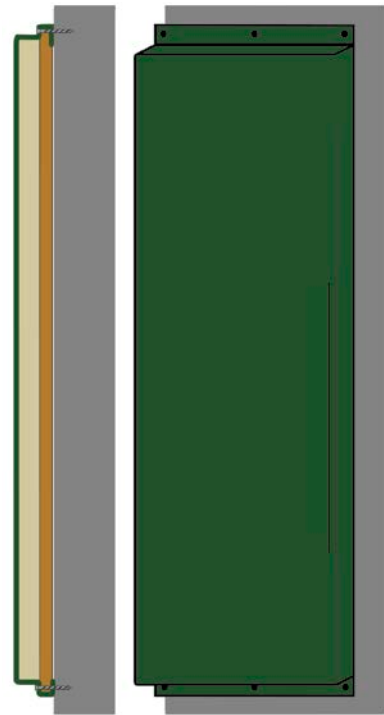
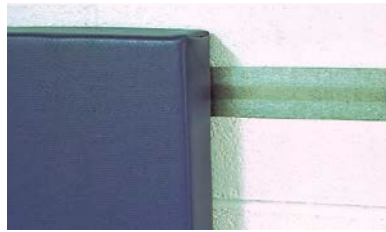

○ Custom Printing

Our vinyl fabrics can be digitally printed with our high-quality UV digital printing process. Our elite printing process allows us to print directly on our material. Your investment will not crack peel or tear like vinyl decals. Our digital printing allows for more detailed multi-colored capabilities and has a quick turnaround and greater accuracy.



Color Options - 14 OZ. FR VINYL (Standard colors are forest green, black, royal blue, navy blue, and red.)

YELLOW	GOLD	ORANGE	RED	MAROON	KELLY GREEN	FOREST GREEN	TAN
LIGHT BLUE	CHAMPION BLUE	ROYAL BLUE	NAVY	PURPLE	WHITE	BLACK	GRAY



Custom Sewn Padding

Protective padding that is custom sewn to your specifications. Cushion tapered columns, I-beams, posts or whatever obstacles are in a facility. Durable double sewn padding is 2", 3" or 4" thick high-impact foam with no plywood backing. The high-impact foam is wrapped in durable long lasting vinyl. Flame resistant vinyl cover meets the state of California Fire Marshall requirements. Reinforced double sewn padding can be installed with grommets, Velcro or glued on. Measurements and/or drawings must be provided when ordering.

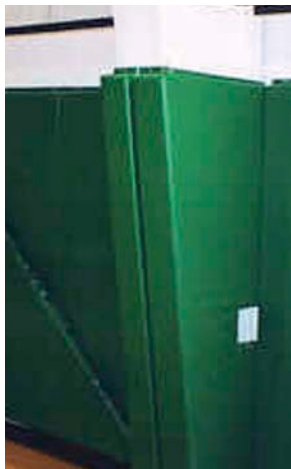
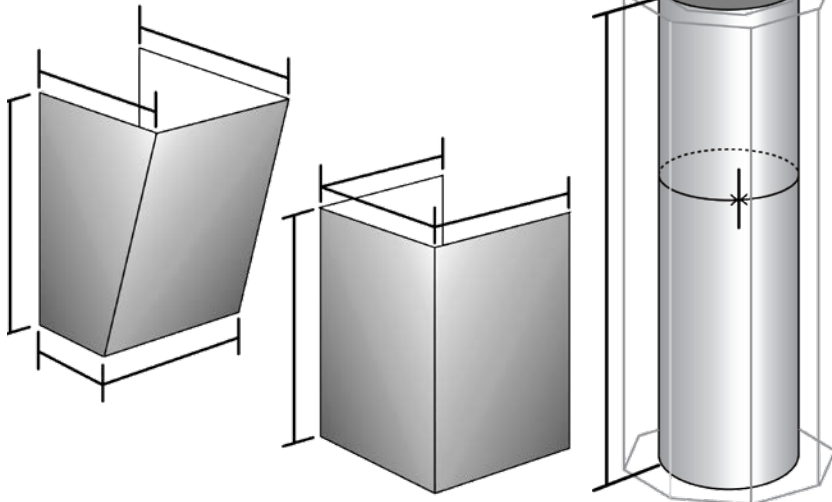

I-Beam Wrap Pads

Protective I-Beam Wrap Pads use a channel design to cover the front and sides of the I-beam's face and edges. Standard size panels are 6' high x 2" thick. I-beam padding is custom made for up to a 12" wide beam face. The two inch thick high-impact foam is wrapped in durable long lasting vinyl. The flame resistant vinyl is antibacterial, anti-fungal, rot and mildew resistant, and fire retardant to meet all standard fire codes including NFPA 701 and California Fire Marshall. Reinforced double sewn padding easily attaches with industrial adhesive Velcro. Velcro is provided to adhere to backside of the I-beam face.

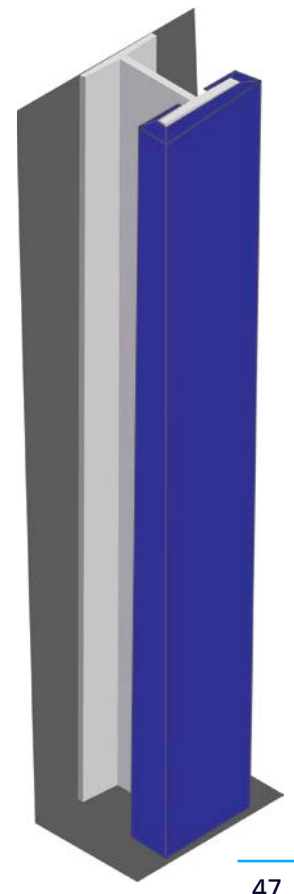

1-800-553-8907
douglas-sports.com



USA MANUFACTURER